



IoT module EVK hardware user guide

- XM122, XB122, XA122



IoT module EVK hardware user guide
- XM122, XB122, XA122

Author: Acconeer

Version 1.5: 2023-12-08

Acconeer AB



Table of Contents

- 1. Overview of the XM122/XB122/XA122 IoT Module Evaluation Kit..... 4
 - 1.1. Introduction 4
 - 1.2. Getting Started..... 5
- 2. Software for the EVK..... 6
 - 2.1. SW download 6
 - 2.2. SW API Description..... 6
- 3. The EVK Hardware..... 7
 - 3.1. XB122 Breakout Board 8
 - 3.1.1. Overview 8
 - 3.1.2. Power..... 9
 - 3.1.3. Electrical Schematics..... 10
 - 3.1.4. Bill of Material 13
 - 3.1.5. Component Placement Drawing..... 14
 - 3.1.6. Connectors..... 15
 - 3.2. XM122 IoT Module 18
 - 3.2.1. Overview 18
 - 3.2.2. Electrical Schematics..... 19
 - 3.2.3. Bill of Material 23
 - 3.2.4. Component Placement Drawing..... 25
 - 3.2.5. Pinning..... 26
 - 3.2.6. Using the IoT module without the breakout board or battery board 27
 - 3.3. XA122 Battery Board..... 28
 - 3.3.1. Overview 28
 - 3.3.2. Electrical Schematics..... 29
 - 3.3.3. Bill of Material 30
 - 3.3.4. Component Placement Drawing..... 30
 - 3.3.5. Connectors..... 31
 - 3.3.6. Test Points 32
- 4. Safety..... 33
 - 4.1. Electrostatic precautions..... 33
- 5. Regulatory Information 34
- 6. Revision History..... 35
- 7. Disclaimer 36



1. Overview of the XM122/XB122/XA122 IoT Module Evaluation Kit

1.1. Introduction

The XM122/XB122/XA122 IoT Module Evaluation Kit (The EVK) is a development platform that is optimized for IoT use cases where low power is important, and the device is expected to run on battery.

The EVK features Acconeer's A111 radar sensor. This is an optimized low-power, high-precision 60 GHz radar with antenna in package (AiP) and integrated baseband. Together with the low power nRF52840 Bluetooth SoC, the XM122 IoT module becomes a powerful radar sensor for IoT applications.

The A111 is based on pulsed coherent radar technology (PCR). It has leading-edge patented sensor technology with pico-second time resolution. The A111 sets a new benchmark as far as power consumption and distance accuracy are concerned and it comes fully integrated in a small package of 29 mm².

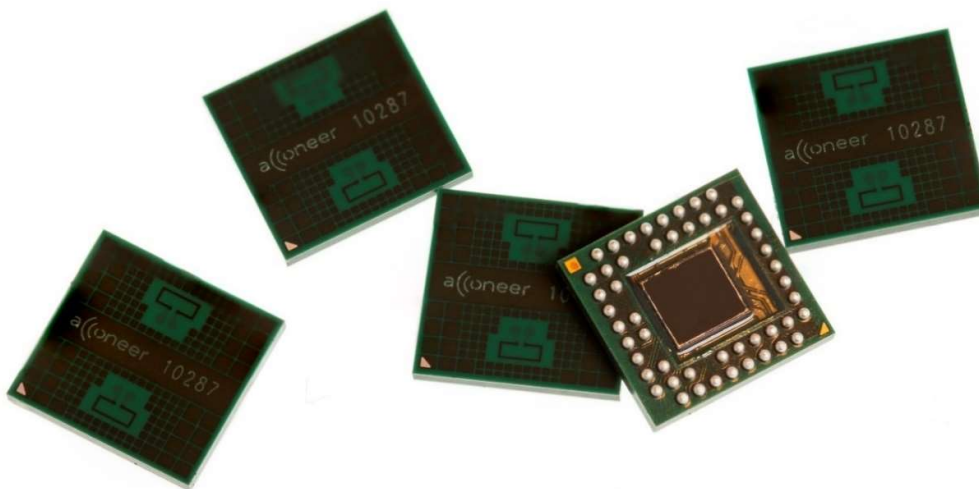

The A111 can measure absolute distance with mm accuracy up to a range of 2 m with a continuous sweep update frequency of up to 600 Hz. With the use of a dielectric lens the range can be significantly longer.

The A111, 60 GHz radar is not compromised by natural sources of interference such as noise, dust, color, direct or indirect light.

The EVK consists of

- 1 XM122 IoT Module including an nRF52840
- 1 XB122 Breakout board to enable easy flashing and logging.
- 1 XA122 Battery board, optional part that can be used for PoC or similar where form factor is key.



1.2. Getting Started

A Quick Installation Guide is available at <https://www.youtube.com/channel/UC56HMJfKPSpamS-kMHXOcAw>

This short instruction video will ensure a smooth setup and installation. For more information on retrieving the Acconeer SW, please refer to the next chapter.



2. Software for the EVK

2.1. SW download

The SW is available for download at <https://developer.acconeer.com> both an Software Development Kit and a Module Server version. SW User Guides can be downloaded at the same location.

2.2. SW API Description

The Acconeer SW comes with an API (Application Programming Interface). Acconeer provides several service-oriented example and reference applications, as well as customer guidelines for application development when utilizing the API. All APIs provided by Acconeer are documented.

Unzip the SW zip file downloaded from Acconeer's download site. In the file structure, please locate /doc folder from where API documentation in HTML format is found at doc/html/index.html.



3. The EVK Hardware

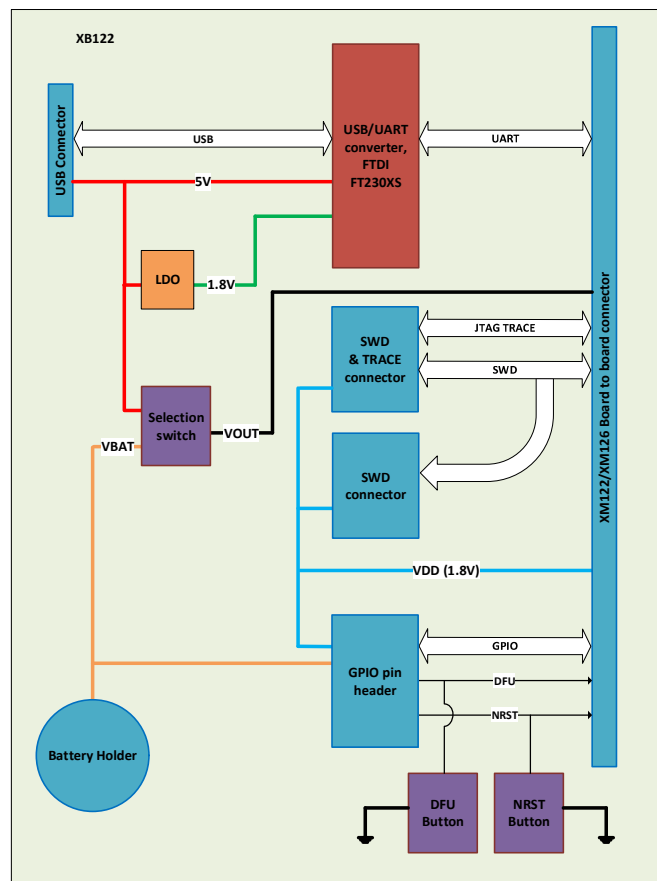
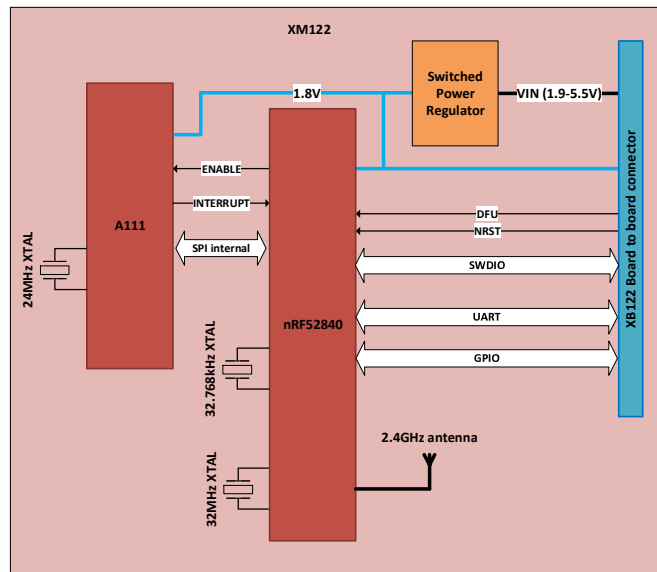

Figure 1 The block diagram of the EVK.



3.1. XB122 Breakout Board

3.1.1. Overview

The XB122 is a breakout-board designed for the XM122/XM126 IoT Module. It makes the interfaces from the XM122/XM126 module accessible for evaluation and debug. It also enables flashing of the XM122/XM126 via USB-UART or SW-DP. The XM122/XM126 is connected to the XB122 via a board-to-board connector on the top side of the PCB. In Picture 1 you will find the XB122 top side. Picture 2 shows the bottom side of XB122.

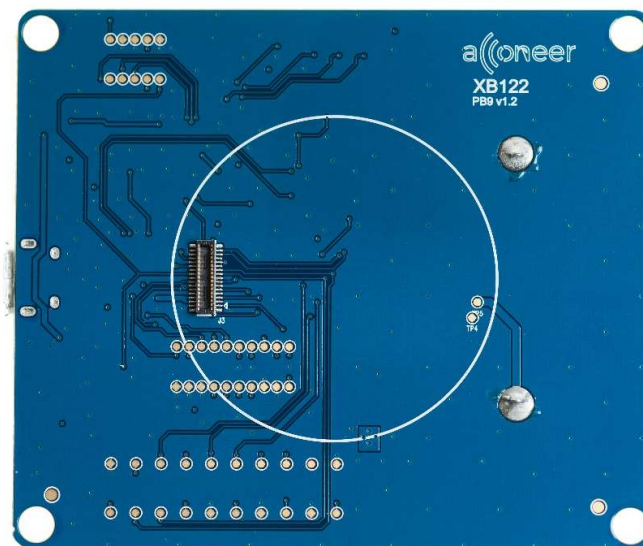

Picture 1

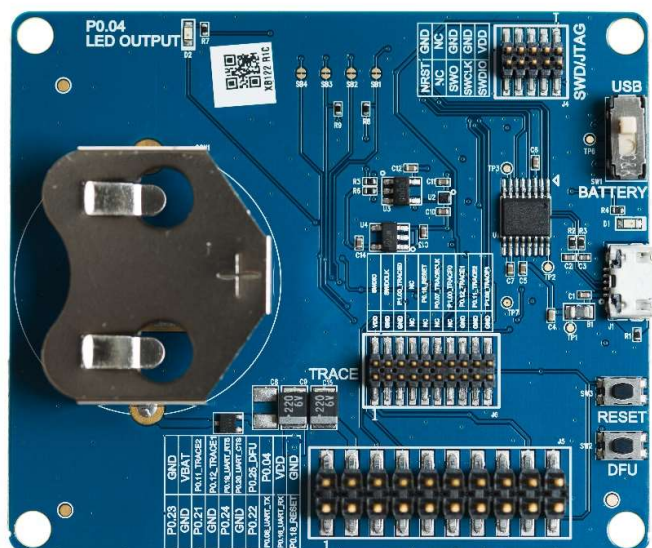

Picture 2



3.1.2. Power

The XB122 is powered via the USB connector. The USB 5V power domain supplies the USB-UART chip (U1). If the USB-UART interface is not used, a dedicated USB charger can be used.

When the LED D1 on the XB122 is lit, the USB-UART chip is powered and ready to use. If SW1 is set to “VBUS” it also means that XM122/XM126 is powered and ready to use (if connected to the board-to-board connector on the top side of XB122).

The XM122/XM126 can be powered either from the USB 5V power domain or from a CR2477 battery connected to the battery connector CON1. The CR2477 battery is not included in the EVK. The power source for XM122/XM126 is determined by the setting of the switch “SW1”. The XM122/XM126 is powered via the board-to-board connector J3. If XM122/XM126 is powered from the battery, the XB122 can still be powered from the USB 5V. If one doesn't want to use the USB-UART interface and XM122/XM126 is powered from the battery, the USB can be left unconnected. For details regarding the power management on XB122, refer to the XB122 product brief.



3.1.3. Electrical Schematics

On the following pages, please find the electrical schematics for the XB122.

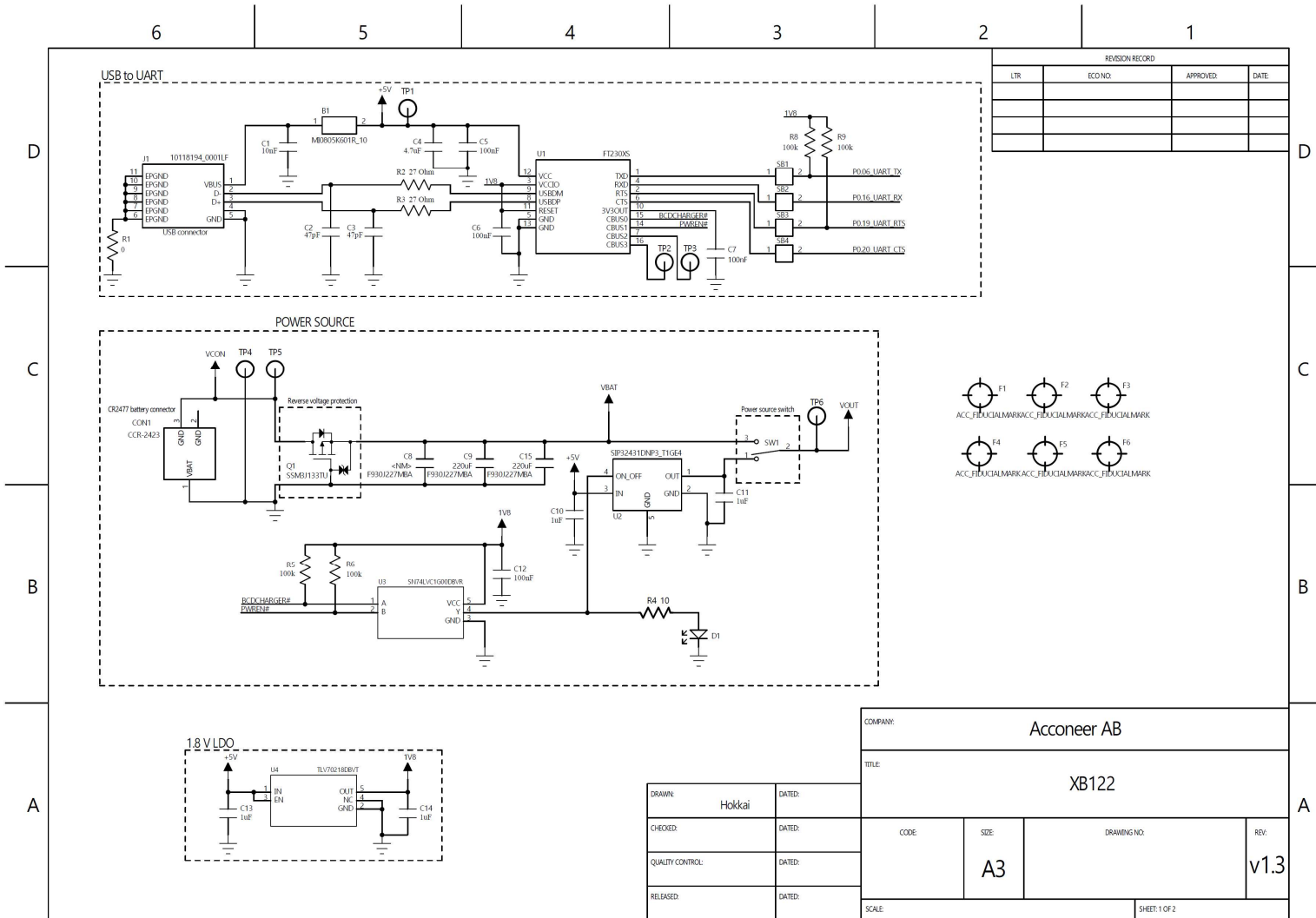

REVISION RECORD			
LTR	ECD NO.	APPROVER	DATE

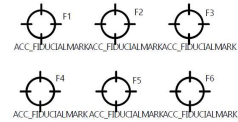

COMPANY: Acconeer AB			
TITLE: XB122			
CODE:	SIZE: A3	DRAWING NO:	REV: v1.3
SCALE:			SHEET: 1 OF 2

DRAWN: Hokkai	DATED:
CHECKED:	DATED:
QUALITY CONTROL:	DATED:
RELEASED:	DATED:

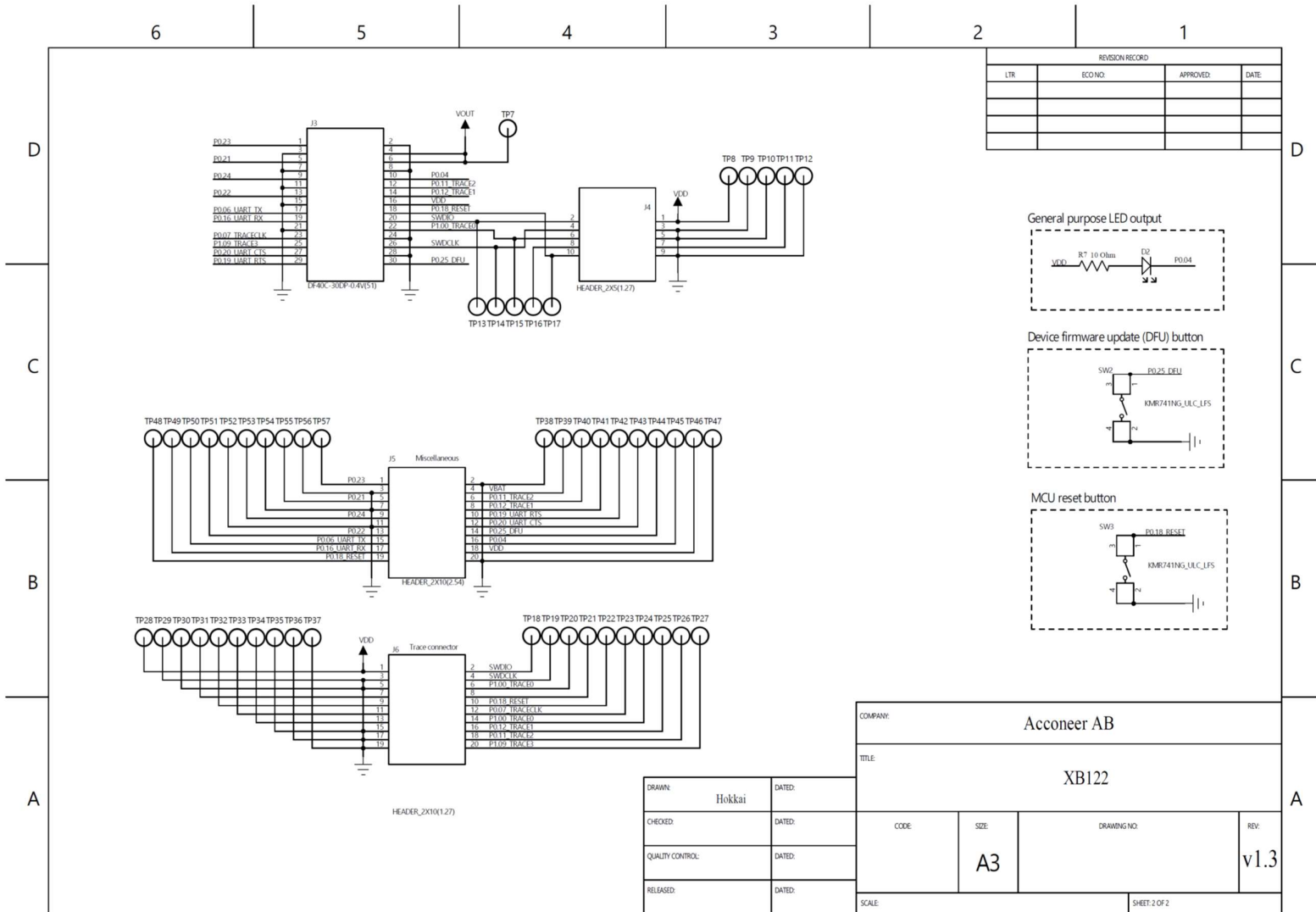

REVISION RECORD			
LTR	ECO NO.	APPROVED:	DATE

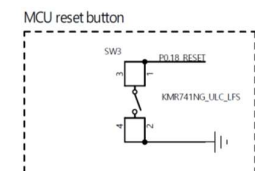
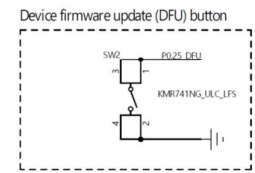
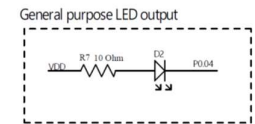

COMPANY: Acconeer AB			
TITLE: XB122			
CODE	SIZE: A3	DRAWING NO.	REV: v1.3
SCALE:			SHEET: 2 OF 2

DRAWN: Hokkai	DATED:
CHECKED:	DATED:
QUALITY CONTROL:	DATED:
RELEASED:	DATED:



3.1.4. Bill of Material

Table 1 shows the BOM for the XB122

Table 1 The BOM for the XB122.

Component Ref.	Specification	QTY	Value	Comment
B1	MI0805K601R-10/Ferrite Bead	1		Manufacturer: LAIRD
C1	10/NF/K/16V/X7R/1005	1	10nF	
C2,C3	47/PF/J/50V/C0G/1005	2	47pF	
C4	4.7/UF/M/10V/X5R/1005	1	4.7uF	
C5,C6,C7,C12	100/NF/K/50V/X7R/1005	4	100nF	
C9,C15	220/UF/M/6.3V/NP0/3528	2		Manufacturer: AVX Part number: F930J227MBA
C10,C11,C13,C14	1/UF/K/10V/X5R/1005	4	1uF	
CON1	CR2477 battery holder	1		Manufacturer: RTLECS Part number: CCR2423
D1,D2	631nm LED RED CLEAR CHIP SMD	2		LTST-C193KRKT-5A
J1	Micro B USB 2.0 Receptacle	1		Manufacturer: Amphenol Part number: 10118194_0001LF
J3	DF40C-30DP-0.4V51	1		Manufacturer: Hirose
J4	10 position pin header, 1.27mm	1		Manufacturer: SAMTEC Part number: FTSH-105-01-F-DV-P-TR
J5	20 position pin header, 2.54mm	1		Manufacturer: SAMTEC Part number: TSM-110-01-F-DV-P-TR
J6	20 position pin header, 1.27mm	1		Manufacturer: SAMTEC Part number: FTSH-110-01-F-DV-P-TR
R1	0/OHM/J/1005	1	0 Ohm	
R2,R3	27/OHM/F/1005	2	27 Ohm	
R4,R7	10/OHM/F/1005	2	10 Ohm	
R5,R6,R8,R9	100/KOHM/F/1005	4	100 kOhm	
SW1	SPDT Switch	1		Manufacturer: C&K Part Number: JS102011JCQN
SW2,SW3	Switch	2		Manufacturer: C&K Part number: KMR741NG ULC LFS
U1	FT230XS-R/USB to UART bridge	1		



U2	TPS22916BYFPR	1		
U3	SN74LVC1G00DBVR	1		
U4	TLV70218DBVT	1		
Q1	SSM3J133TU	1		

3.1.5. Component Placement Drawing

The component placement drawing of XB122 is found below.

Top Side:

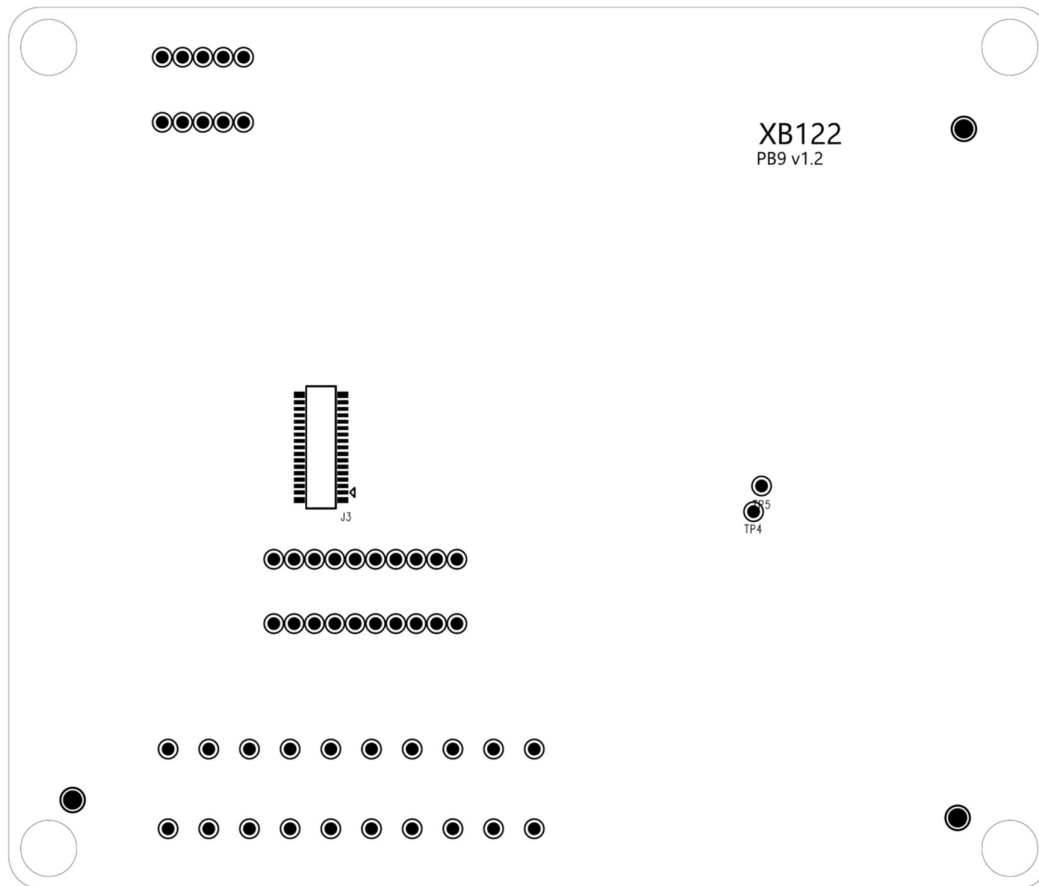

Bottom Side:

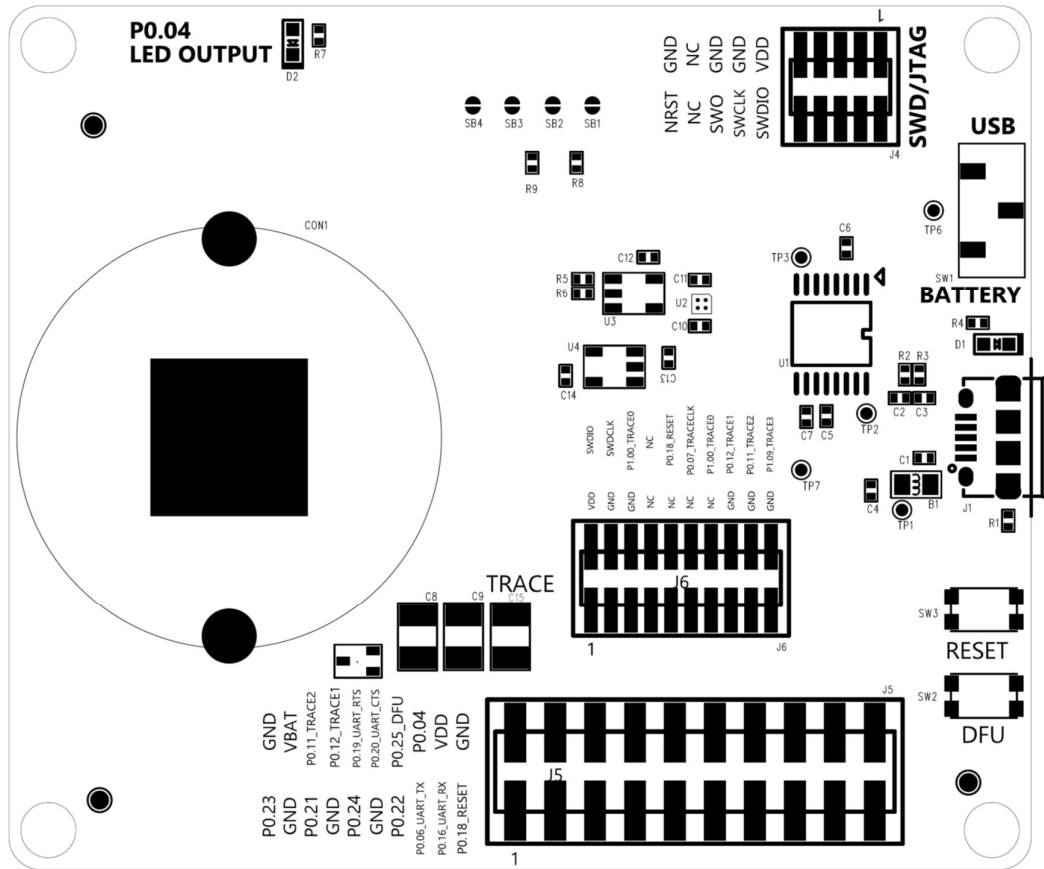

3.1.6. Connectors

USB (J1)

USB is used as power supply for the XB122 and the XM122/XM126 as well as for flashing and communicating over UART. USB is connected to the FTDI chip FT230XS which converts the UART interface from XM122/XM126 into USB data signals. The pinout of J1 is shown in Table 2.

Table 2. The pinout of J1.

Pin Number	Signal
1	VBUS
2	D-
3	D+
4	ID (GND)
5	GND

30 pin board-to-board connector (J3)

The 30-pin board-to-board connector is intended to connect the XM122/XM126 to the XB122. The pinout is found in Table 3.



Table 3. The pinout of J3.

Pin Number	Signal	Pin Number	Signal
1	GPIO P0.23 ¹	2	GND
3	GND	4	VOUT (1.9-5.5V)
5	GPIO P0.21 ¹	6	VOUT (1.9-5.5V)
7	GND	8	GND
9	GPIO P0.24 ¹	10	GPIO P0.04
11	GND	12	GPIO P0.11/ TRACEDATA2
13	GPIO P0.22 ¹	14	GPIO P0.12/ TRACEDATA1
15	GND	16	VDD (Regulated 1.8V output voltage)
17	GPIO P0.06/ UART_TX	18	nRESET
19	GPIO P0.16/ UART_RX	20	SWDIO
21	GND	22	SWO/ GPIO P1.00/ TRACEDATA0
23	GPIO P0.07/ TRACECLK	24	GND
25	GPIO P1.09/ TRACEDATA3	26	SWDCLK
27	GPIO P0.20/ UART_CTS	28	GND
29	GPIO P0.19/ UART_RTS	30	GPIO P0.25/ DFU

2x5 JTAG/SWD pin header (J4)

The 2x5 JTAG/SWD pin header (1.27mm pitch) contains the signals needed for flashing the XM122/XM126 MCU via the SWD interface. The pinout matches that of the Cortex 10-pin JTAG/SWD Connector and is found in Table 4.

Table 4. The pinout of J4.

Pin Number	Signal	Pin Number	Signal
1	1.8V	2	SWDIO
3	GND	4	SWDCLK
5	GND	6	TRACESWO
7	NC	8	NC
9	GND	10	NRST

¹ On XB122, the routing of GPIOs P0.23, P0.21, P0.24 and P0.22 between J3 and J5 has been optimized for SPI interface configuration.



2x10 pin header (J5)

The 2x10 pin header (2.54mm pitch) contains miscellaneous GPIOs from the XM122/XM126 as well as VBAT. The pinout is found in Table 5.

Table 5. The pinout of J5.

Pin Number	Signal	Pin Number	Signal
1	GPIO P0.23	2	GND
3	GND	4	VBAT
5	GPIO P0.21	6	GPIO P0.11/ TRACE2
7	GND	8	GPIO P0.12/ TRACE1
9	GPIO P0.24	10	GPIO P0.19/ UART_RTS
11	GND	12	GPIO P0.20/ UART_CTS
13	GPIO P0.22	14	GPIO P0.25/ DFU
15	GPIO P0.06/ UART_TX	16	GPIO P0.04
17	GPIO P0.16/ UART_RX	18	VDD (Regulated 1.8V output voltage)
19	nRESET	20	GND

Switches and buttons

There is one switch on XB122. SW1 determines if XM122/XM126 is powered from the USB 5V power domain or from a CR2477 coin cell battery. In Table 6 the position of the switch and the corresponding power source output is shown.

Table 6. The connected terminal of the switch SW1 and corresponding VOUT.

Connected Terminal	VOUT = 5V	VOUT = VBAT
1	TRUE	FALSE
2	FALSE	TRUE

There are two buttons on the XB122. SW2 controls the signal “DFU” (Device Firmware Upgrade) connected to XM122/XM126 and SW3 controls “NRST” connected to the XM122/XM126. In Table 7 the state of the buttons and the corresponding signal states are listed.

Table 7. The states of the switches SW2 and SW3.

Button	Open (default)	Closed
SW2	DFU=1	DFU=0
SW3	NRST=1	NRST=0



3.2. XM122 IoT Module

3.2.1. Overview

Picture 3 shows the XM122 IoT Module top side and Picture 4 shows the bottom side.



Picture 3

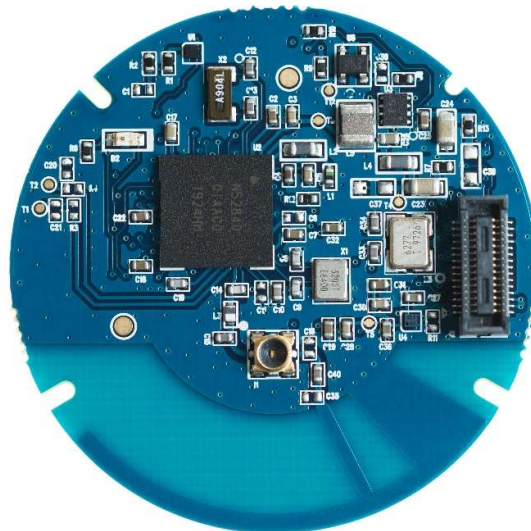

Picture 4



3.2.2. Electrical Schematics

Please find the electrical schematics of the XM122 R2D below.

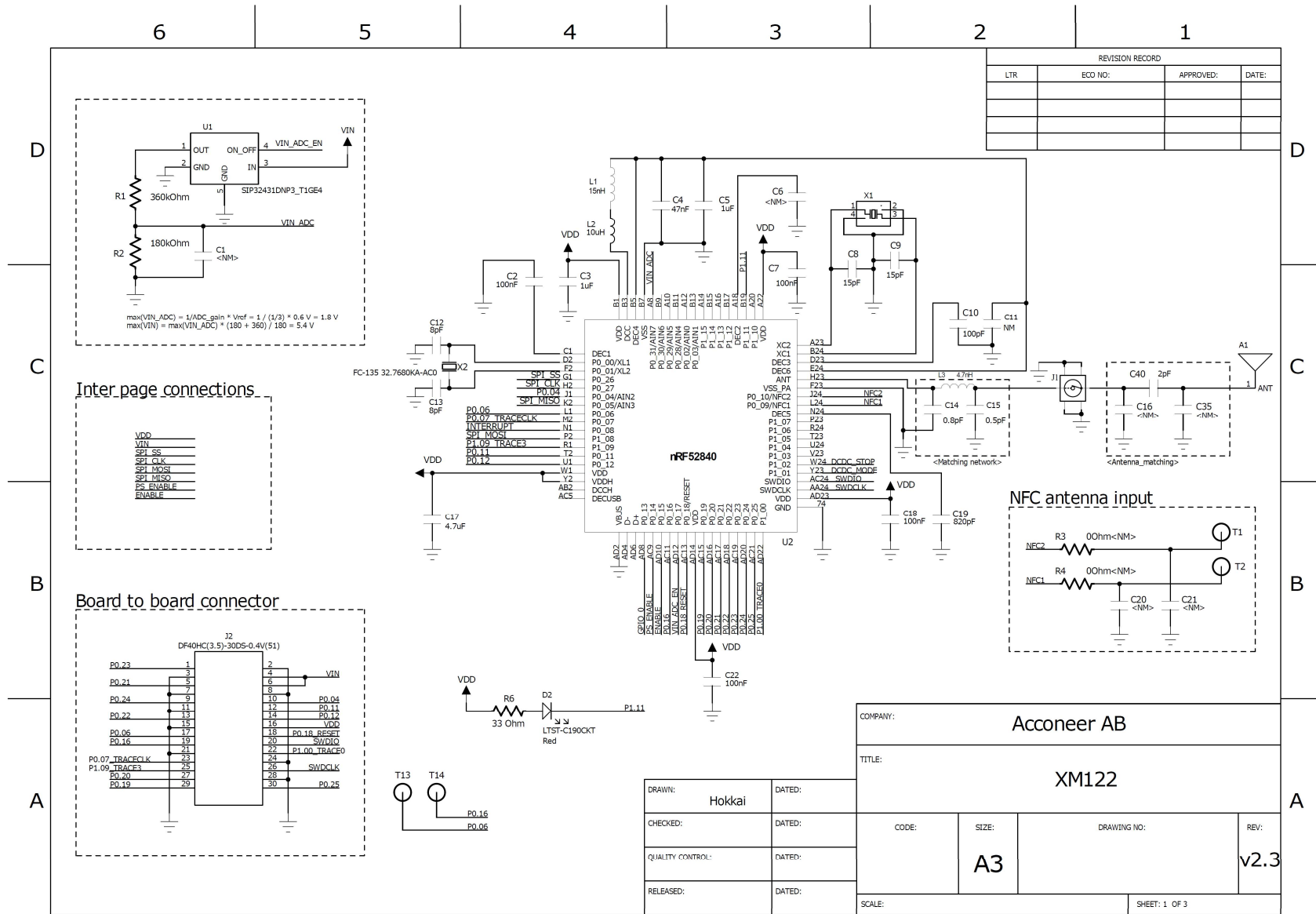

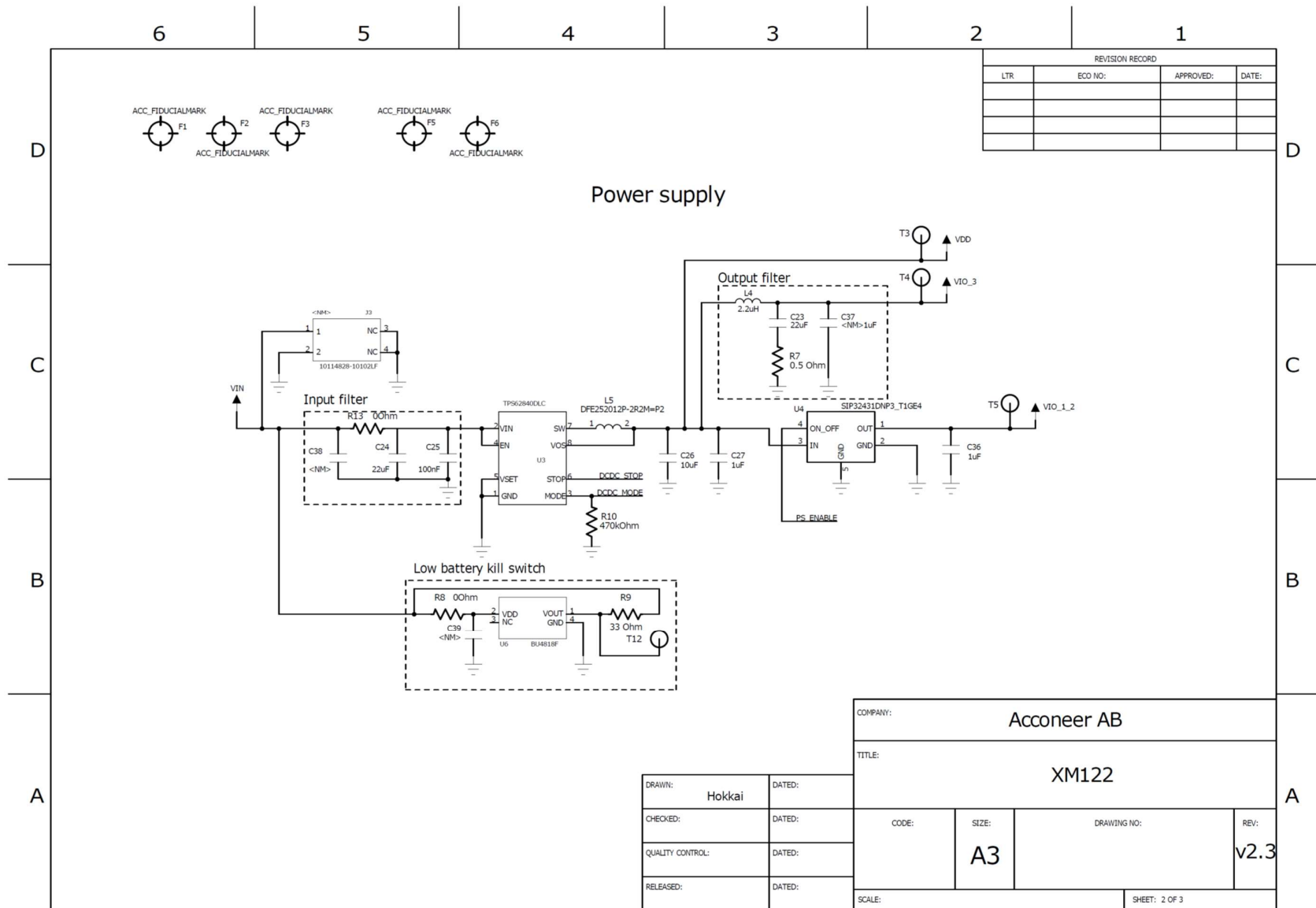

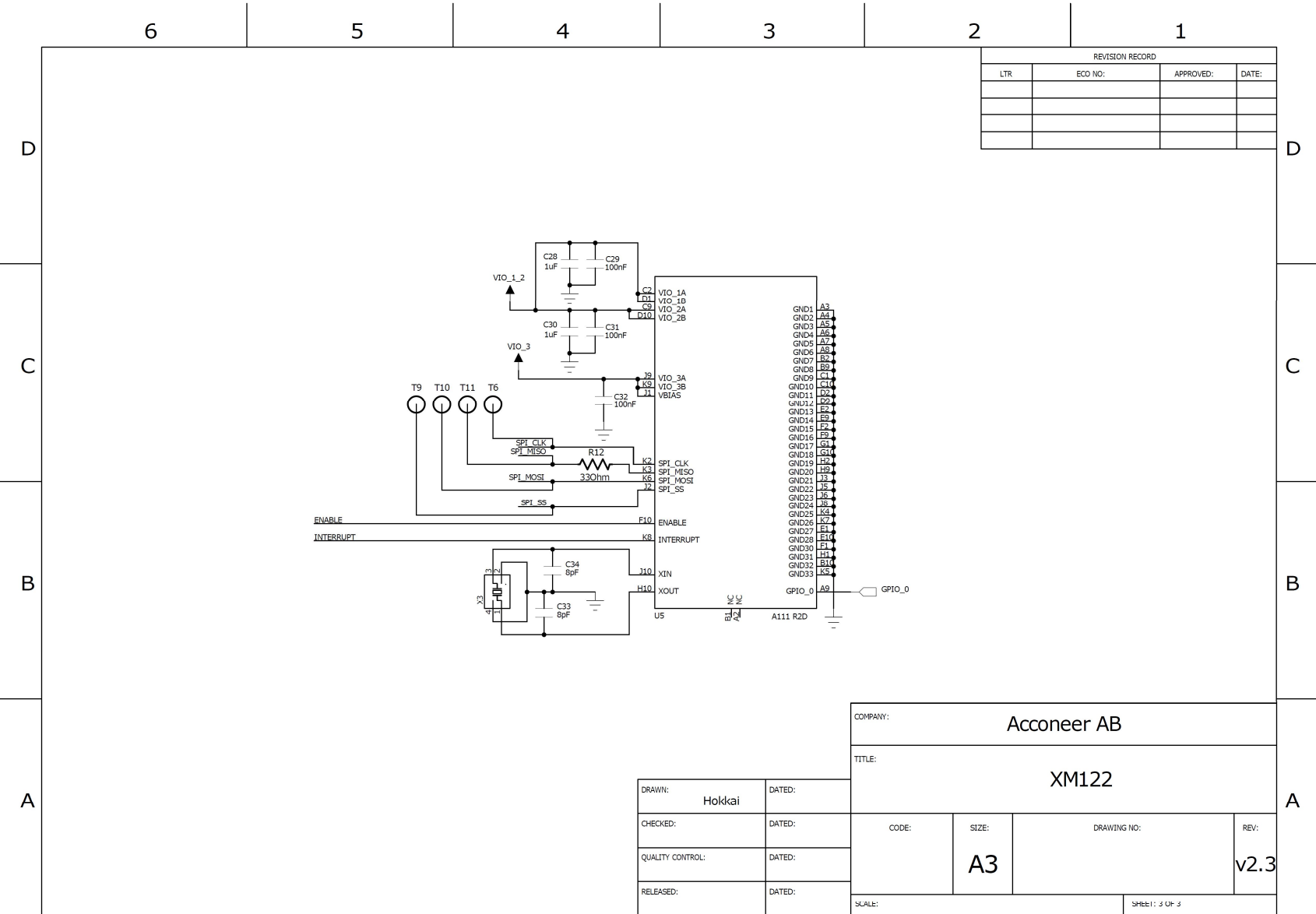



3.2.3. Bill of Material

Table 8 shows the BOM for the XM122 R2D.

Table 8 The BOM for XM122 R2D

Component Ref.	Specification	QTY	Value	Comment
C2,C7,C18,C22,C25,C29,C31,C32	100/NF/10%/50V/X7R/M1005	8	100 nF	
C3,C5,C27,C28,C30,C36	1/UF/10%/10V/X5R/M1005	6	1uF	
C4	47/NF/10%/50V/X5R/M1005	1	47nF	
C8,C9	15/PF/5%/50V/NP0/M1005	2	15pF	
C10	100/PF/5%/10V/NP0,COG/M1005	1	100pF	
C12,C13,C33,C34	8/PF/0.25%/50V/NP0,COG/M1005	4	8pF	
C14	0.75/PF/0.1%/50V/COG/M1005	1	0.8pF	
C15	0.5/PF/0.25%/50V/COG/M1005	1	0.5pF	
C17	4.7/UF/20%/10V/X5R/M1005	1	4.7uF	
C19	820/PF/1%/50V/NP0/M1005	1	820pF	
C23,C24	22/UF/20%/10V/X5R/M1608	2	22uF	
C26	10/UF/20%/10V/X5R/M1005	1	10uF	
C40	2/PF/0.25%/50V/N/A/M1005	1	2pF	
D2	LTST-C190CKT	1		638nm LED RED CLEAR CHIP SMD
J1	MM8130-2600	1		



J2	DF40HC(3.5)-30DS-0.4V(51)	1		Manufacturer: Hirose
L1	15/NH/5%/320mOhm/M1005/	1	15nH	Manufacturer: Murata Part number: LQG15HS15NJ02
L2	10uH/20%/600mOhm/M1608	1	10uH	Manufacturer: TDK Part number: MLZ1608N100LT000
L3	4.7nH/0.3nH/110mOhm/M1005	1	4.7nH	Manufacturer: TDK Part number: MHQ1005P4N7ST000
L4	2.2uH/20%/180mOhm/M1608	1	2.2uH	Manufacturer: TDK Part number: MLZ1608N2R2LT000
L5	2.2uH/20%/144mOhm/M2016	1	2.2uH	Manufacturer: Murata Part number: DFE252012P-2R2M=P2
R1	360/Kohm/5%/M1005	1	360 kOhm	0.0625W@70°C, 50V
R2	180/KOHM/1%/M1005	1	180kOhm	0.0625W@70°C, 50V
R6, R9, R12	33/OHM/1%/M1005	3	33 Ohm	0.0625W@70°C, 50V
R7	0.5/OHM/5%/M1005	1	0.5 Ohm	0.0625W@70°C, 50V
R8, R13	0/OHM/5%/M1005	2	0 Ohm	0.0625W@70°C, 50V
R10	470/KOHM/1%/M1005	1	470 kOhm	0.0625W@70°C, 50V
U1, U4	SIP32431DNP3_T1GE4	2		
U2	NORDIC_BT5.0_LONGRANGE_NRF52840	1		NRF52840_QIAA
U3	TPS62840DLCR	1		
U5	A111 R2D	1		
U6	BU4818F-TR	1		



X1	32MHz/10ppm/10PF/50OHM/2520	1		
X2	32.768kHz/20ppm/9.5PF/90KOHM/2	1		
X3	TSX-3225 24.0000MF20G-AC0/SMD	1		

3.2.4. Component Placement Drawing

The component placement drawing of XM122 R2D is found below.

Top side:

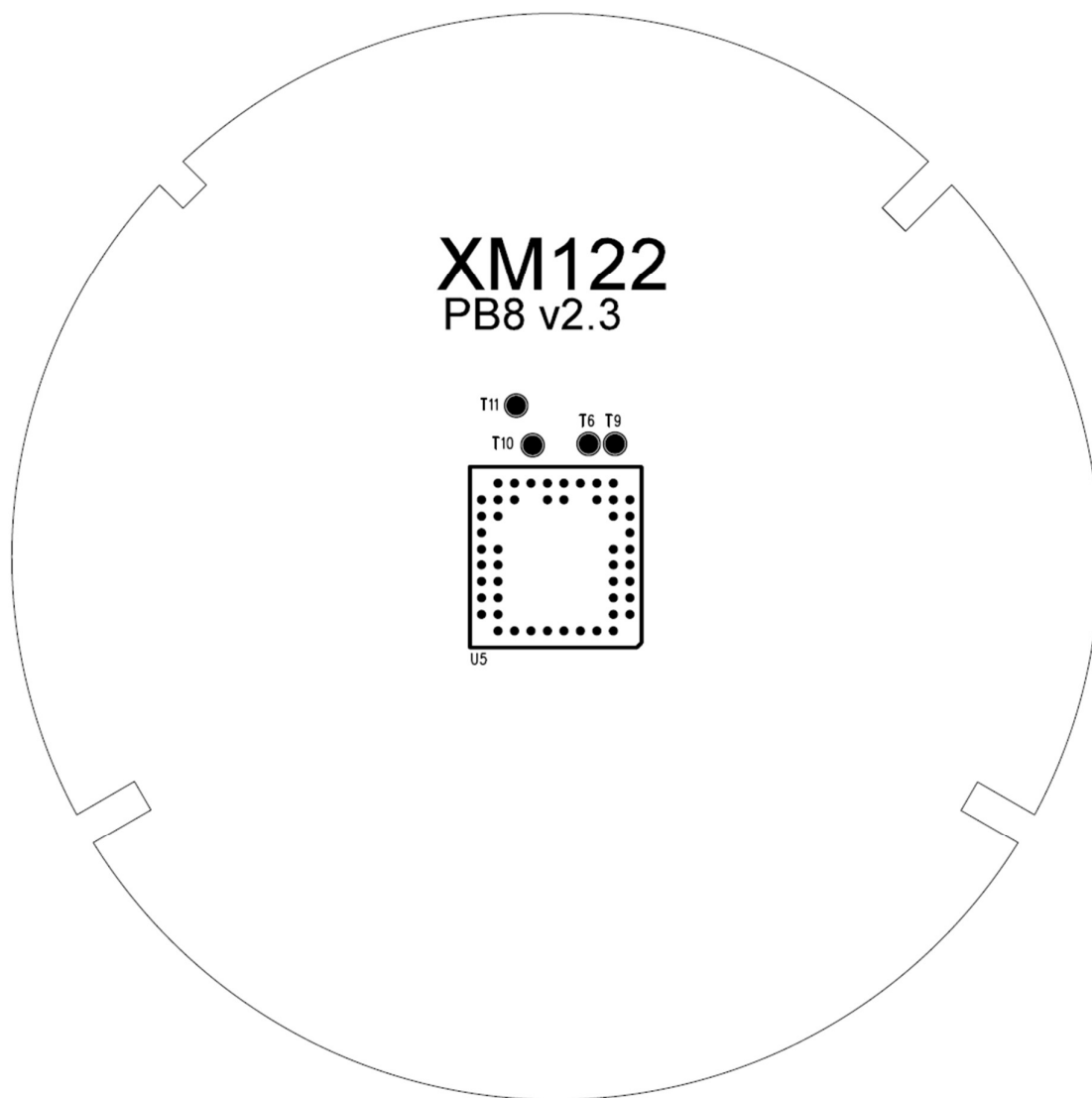

Bottom side:

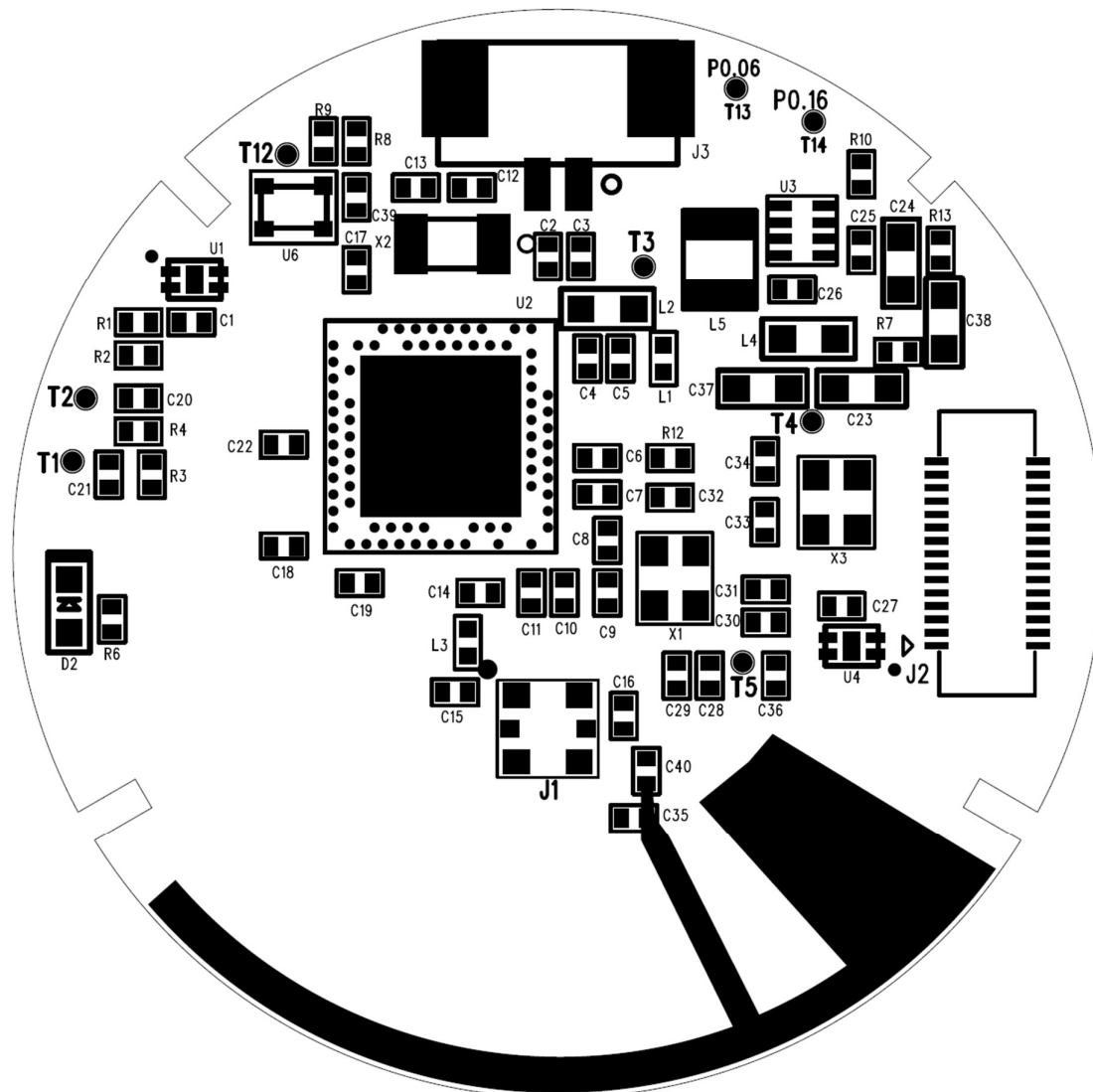

3.2.5. Pinning

Table 9 shows the pinout of the XM122 connector J2.

Table 9 The pinout of the XM122 connector J2.

Pin Number	Signal	Pin Number	Signal
1	GPIO P0.23	2	GND
3	GND	4	VIN
5	GPIO P0.21	6	VIN
7	GND	8	GND
9	GPIO P0.24	10	GPIO P0.04
11	GND	12	GPIO P0.11/ TRACEDATA2
13	GPIO P0.22	14	GPIO P0.12/ TRACEDATA1



Pin Number	Signal	Pin Number	Signal
15	GND	16	VDD (Regulated 1.8 V output voltage)
17	GPIO P0.06	18	nRESET
19	GPIO P0.16	20	SWDIO
21	GND	22	SWO/ GPIO P1.00/ TRACEDATA0
23	GPIO P0.07/ TRACECLK	24	GND
25	GPIO P1.09/ TRACEDATA3	26	SWDCLK
27	GPIO P0.20	28	GND
29	GPIO P0.19	30	GPIO P0.25/ DFU

3.2.6. Using the IoT module without the breakout board or battery board

The IoT module can be used without connecting it to the board-to-board connector if external power is supplied. In this way the XM122 can operate as a standalone module or connected to other hardware. In XM122 R2D a NOT MOUNTED battery connector has been added to the design. Refer to XM122 datasheet for details. For XM122 R2C, power supply leads or connection to a battery can be soldered onto the pads of C38 (not mounted), see Figure 2.

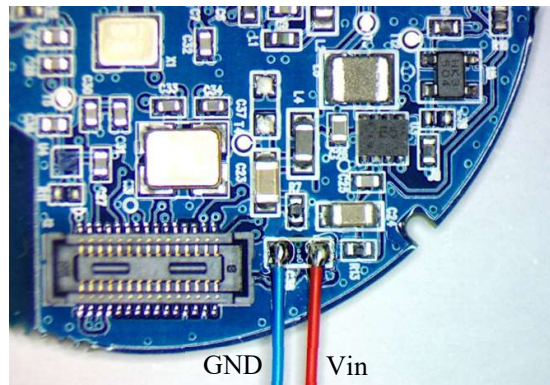

Figure 2 Connecting external power to the XM122 R2C



3.3. XA122 Battery Board

3.3.1. Overview

The latest addition to the IoT module EVK is the battery board XA122 which is designed to be used with the XM122/XM126 IoT module, enabling a battery-powered radar module in a small formfactor. XA122 is ideal to use for battery-powered applications where formfactor is key. The XA122 is optimized with regards to size and does not facilitate flashing or debugging. For that purpose, XB122 is recommended.

The XA122 battery board is easily connected to the XM122/XM126 IoT module via a board-to-board connector and contains a CR2477 battery holder (battery NOT included), tantalum capacitors for handling current peaks from the XM122/XM126 IoT module and a switch preventing the battery from being short-circuited if inserted incorrectly. It also enables access to some of the interfaces in the board-to-board connector via test points.

The picture below shows the XA122 battery board. The leftmost picture shows the front side of the XA122, with the board-to-board connector for the XM122/XM126 IoT module, and the rightmost picture shows the reverse side of the XA122.





3.3.2. Electrical Schematics

The electrical schematics for the XA122 is found below:

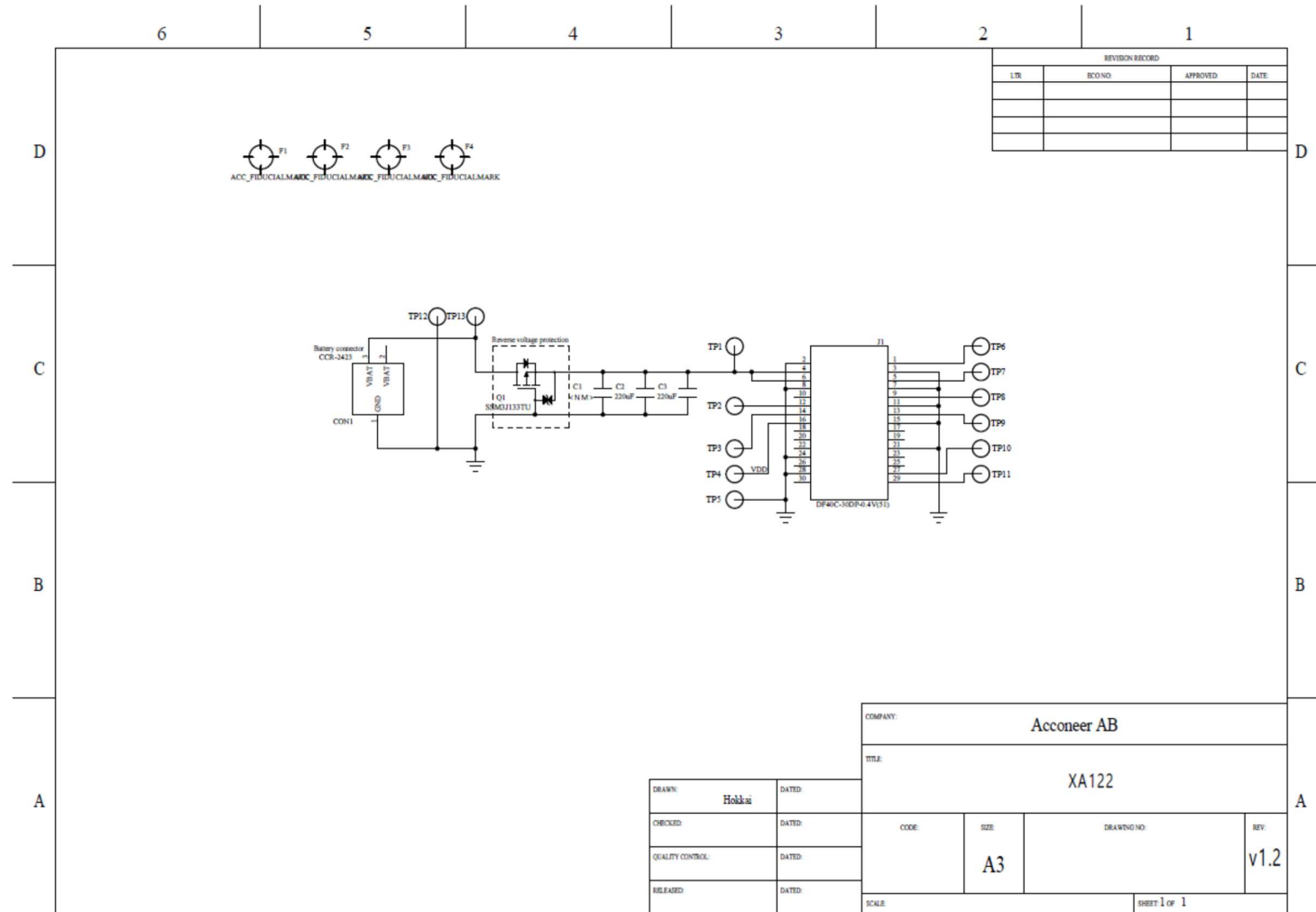

3.3.3. Bill of Material

Table 10 shows the BOM for XA122.

Table 10. The BOM of XA122.

Component Ref.	Specification	QTY	Value	Comment
C2, C3	220/UF/M/6.3V/NP0/3528	2		Manufacturer: AVX Part number: F930J227MBA
CON1	BATTERY RETAINER COIN PC PIN	1		Manufacturer: Keystone electronics Part number: 3039
J1	DF40C-30DP-0.4V51	1		Manufacturer: Hirose
Q1	SSM3J133TU	1		Manufacturer: Toshiba

3.3.4. Component Placement Drawing

The component placement drawing of XA122 is found below.

Top Side:

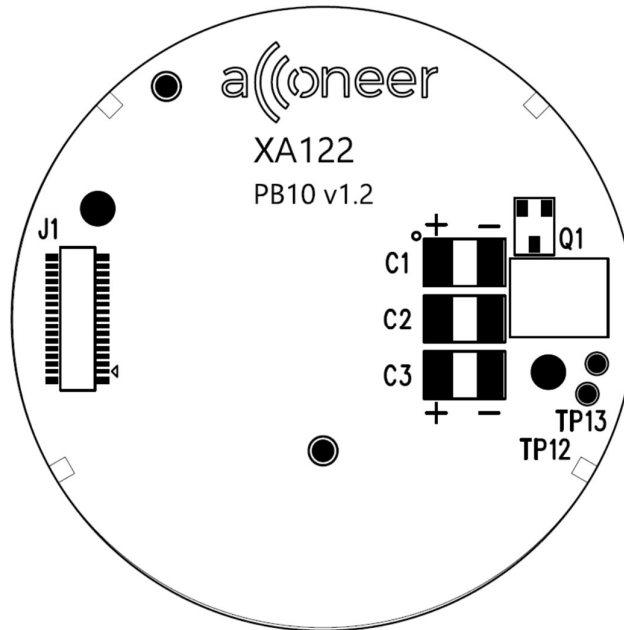

Bottom Side:

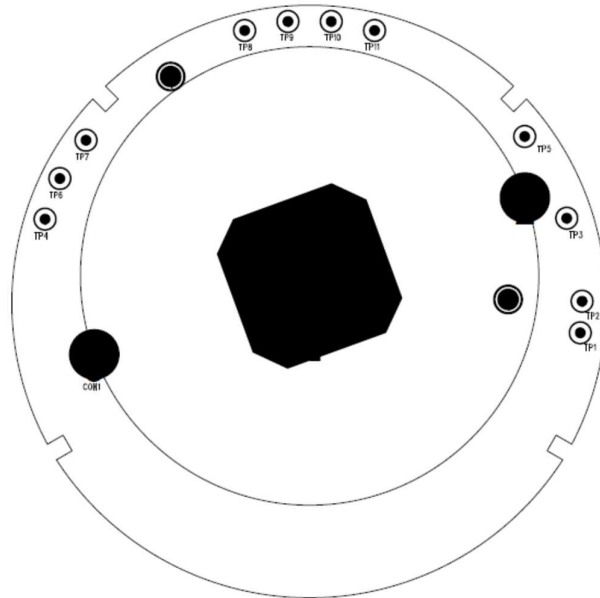

3.3.5. Connectors

30 pin board-to-board connector (J1)

The 30-pin board-to-board connector is intended to connect the XM122/XM126 to the XA122. The pinout is found in Table 3.

Table 11. The pinout of J1.

Pin Number	Signal	Pin Number	Signal
1	GPIO P0.23	2	GND
3	GND	4	VOUT
5	GPIO P0.21	6	VOUT
7	GND	8	GND
9	GPIO P0.24	10	GPIO P0.04
11	GND	12	GPIO P0.11 / TRACEDATA2
13	GPIO P0.22	14	GPIO P0.12 / TRACEDATA1
15	GND	16	VDD (Regulated 1.8V output voltage)
17	GPIO P0.06 / UART_TX	18	nRESET
19	GPIO P0.16 / UART_RX	20	SWDIO
21	GND	22	SWO / GPIO P1.00 / TRACEDATA0



Pin Number	Signal	Pin Number	Signal
23	GPIO P0.07 / TRACECLK	24	GND
25	GPIO P1.09 / TRACEDATA3	26	SWDCLK
27	GPIO P0.20 / UART_CTS	28	GND
29	GPIO P0.19 / UART_RTS	30	GPIO P0.25 / DFU

3.3.6. Test Points

XA122 has 11 test points which makes signals from the XM122/XM126 IoT Module available for probing or external connection. The test points on the bottom side of XA122 are listed in Table 12.

Table 12 The test points on XA122

Test Point	Signal (from XM122/XM126 IoT module)
TP1	VOUT
TP2	GPIO P0.11
TP3	GPIO P0.12
TP4	VDD
TP5	GND
TP6	GPIO P0.23
TP7	GPIO P0.21
TP8	GPIO P0.24
TP9	GPIO P0.22
TP10	GPIO P0.20
TP11	GPIO P0.19



4. Safety

4.1. Electrostatic precautions



Please take electrostatic precautions, including using ground straps, when using the EVK or any of its components. An electrostatic discharge could damage the device.



5. Regulatory Information

Acconeer have no plans to certify the A111 EVK, it is only for evaluation purposes.

Regulatory Compliance for XM122, refer to XM122 datasheet.

Regulatory Compliance for A111, refer to A111 datasheet.



6. Revision History

Date	Revision	Changes
2019-10-02	1.0	Original version
2019-11-25	1.1	Changed naming of document
2020-01-27	1.2	Added section 1.1.6. Updated Table 3 and Table 5 with correct signal names for UART. Updated Table 9 with correct signal names. Updated chapter 3.1.3, "Electrical Schematics" with correct net names for UART signals.
2021-04-21	1.3	ISO 14001 updates
2022-08-24	1.4	Added chapter 3.3 XA122 Battery Board. Updated chapter "Regulatory information".
2023-12-08	1.5	Updated information to include XM126 support for XB122 and XA122. Updated chapters 3.2.2 and 3.2.3 with information of XM122 R2D. Updated Table 8 with more details regarding capacitors, inductors and resistors.



7. Disclaimer

The information herein is believed to be correct as of the date issued. Acconeer AB (“**Acconeer**”) will not be responsible for damages of any nature resulting from the use or reliance upon the information contained herein. Acconeer makes no warranties, expressed or implied, of merchantability or fitness for a particular purpose or course of performance or usage of trade. Therefore, it is the user’s responsibility to thoroughly test the product in their particular application to determine its performance, efficacy and safety. Users should obtain the latest relevant information before placing orders.

Unless Acconeer has explicitly designated an individual Acconeer product as meeting the requirement of a particular industry standard, Acconeer is not responsible for any failure to meet such industry standard requirements.

Unless explicitly stated herein this document Acconeer has not performed any regulatory conformity test. It is the user’s responsibility to assure that necessary regulatory conditions are met and approvals have been obtained when using the product. Regardless of whether the product has passed any conformity test, this document does not constitute any regulatory approval of the user’s product or application using Acconeer’s product.

Nothing contained herein is to be considered as permission or a recommendation to infringe any patent or any other intellectual property right. No license, express or implied, to any intellectual property right is granted by Acconeer herein.

Acconeer reserves the right to at any time correct, change, amend, enhance, modify, and improve this document and/or Acconeer products without notice.

This document supersedes and replaces all information supplied prior to the publication hereof.



Acconeer AB
Västra Varvsgatan 19
211 77 MALMÖ
Sweden

www.acconeer.com
info@acconeer.com
+46 10 218 92 00