



XM126 IoT Module  
Datasheet v1.3



## Abstract

The XM126 is a reference module with optimized formfactor that can be used to support customer in their own design for commercial use, for evaluation and development purpose.

The XM126 is built around the A121 Pulsed Coherent Radar (PCR) sensor and the nRF52840 Bluetooth® 5 SoC (System on Chip) from Nordic Semiconductor and features an integrated antenna for Bluetooth connectivity.

The XM126 can be used as a stand-alone module where customer can embed their application on top of the Acconeer RSS (Radar System Software).

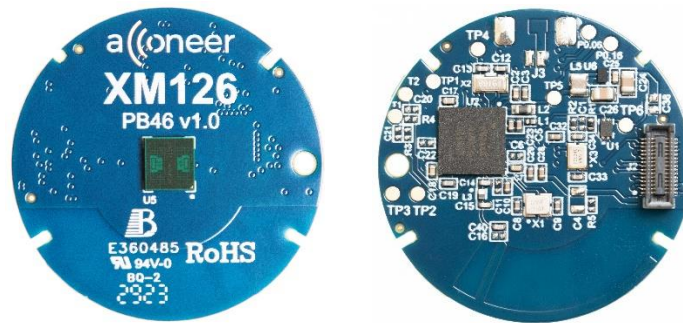

*Figure 1. XM126 Top view (left) and XM126 bottom view (right).*



## Table of Content

1	Revision History .....	4
2	Functional description .....	5
2.1	Overview .....	5
2.2	Product features .....	5
2.3	Block diagram .....	6
2.4	Module board connector and pin description .....	7
2.5	Not mounted battery connector support .....	8
2.6	Software options .....	9
2.7	MAC addresses .....	9
3	Interfaces .....	10
3.1	Module supply input .....	10
3.2	System functions .....	10
3.3	Serial interfaces .....	10
3.4	Digital I/O interfaces .....	10
3.5	Analog I/O interfaces .....	10
3.6	Module reset .....	10
3.7	Debug interface .....	10
4	Electrical specifications .....	11
4.1	Absolute maximum ratings .....	11
4.2	Recommended operating conditions .....	11
4.3	Power consumption summary .....	12
4.4	RF specification .....	13
5	Reference design description .....	14
5.1	Schematics & BOM .....	14
5.2	Component Placement Drawing .....	20
6	Mechanical specifications .....	22
7	Regulatory Approval .....	24
7.1	ETSI .....	24
7.2	FCC Approval .....	25
8	Reference documents .....	26
9	Abbreviations .....	27
	Disclaimer .....	28



# 1 Revision History

Revision	Comment
v1.0	Released version
v1.1	Table 4.5 and 5.1 updated
v1.2	Ch 7.1: EU Type Examination Certificate included
v1.3	Table 4.3 “Low Power Wakeup”-preset power figures updated

This document applies to the following product:

Product name	Part number
XM126	XM126



## 2 Functional description

### 2.1 Overview

The XM126 comes with Nordic nRF52840 SoC and A121 Pulsed Coherent Radar (PCR) sensor, see ref [1]. The Nordic nRF52840 SoC supports Bluetooth 5.4 BLE, Bluetooth Mesh, Thread, Zigbee, 802.15.4, ANT and 2.4 GHz proprietary stacks.

The XM126 is delivered with a bootloader enabling customer to download Acconeer RSS software including SDK (Software Development Kit) for stand-alone usage where customer can embed their own application on top of Acconeer RSS software. Acconeer RSS software provides API to set A121 sensor configuration and to retrieve radar service and detector data.

### 2.2 Product features

The XM126 is an IoT module based on Acconeer A121 pulsed coherent radar (PCR) and the Nordic nRF52840 SoC.

XM126 features:

- The A121 60 GHz Pulsed Coherent radar (PCR) with integrated baseband, RF front-end and Antenna in Package (AiP).
- Low power connected radar module.
- The nRF52840 protocol stack support for Bluetooth 5.4 supporting BLE, Bluetooth mesh, Thread, Zigbee, 802.15.4, ANT and 2.4 GHz proprietary stacks and is built around the 64 MHz ARM® Cortex™-M4 CPU with 256 KB SRAM and 1 MB Flash.
- Integrated 2.4 GHz antenna.
- Optional NFC antenna support for quick Bluetooth pairing via the PCB test points.
- Optimized circular form factor with a diameter of 33 mm.
- Wide single supply operating voltage range 1.8 V to 5.5 V.
- Operating temperature -40° to 85°C.
- External I/F support - SPI, UART, I2C, GPIO, Reset.
- SWD/JTAG for SW flash and debug.

The XM126 can be used for accurate distance measurement, tank level measurement, surface velocity measurement, waste bin level measurement, parking space occupancy, human presence detection, speed measurement, breathing monitoring, gesture control, inventory monitoring and vibration measurement:

- Measures absolute distance up to 20 m, dependent on object, object size, shape, and dielectric properties.
- High precision distance measurements with mm accuracy and high update rate.
- High precision relative measurement with  $\mu\text{m}$  accuracy.
- Human presence detection with high accuracy and the possibility to define multiple detection zones.

Easy integration:

- XM126 can be integrated behind plastic or glass without any need for a physical aperture. See ref [5] *User guide – Sensor Integration Electromagnetic Scattering* for more information.



## 2.3 Block diagram

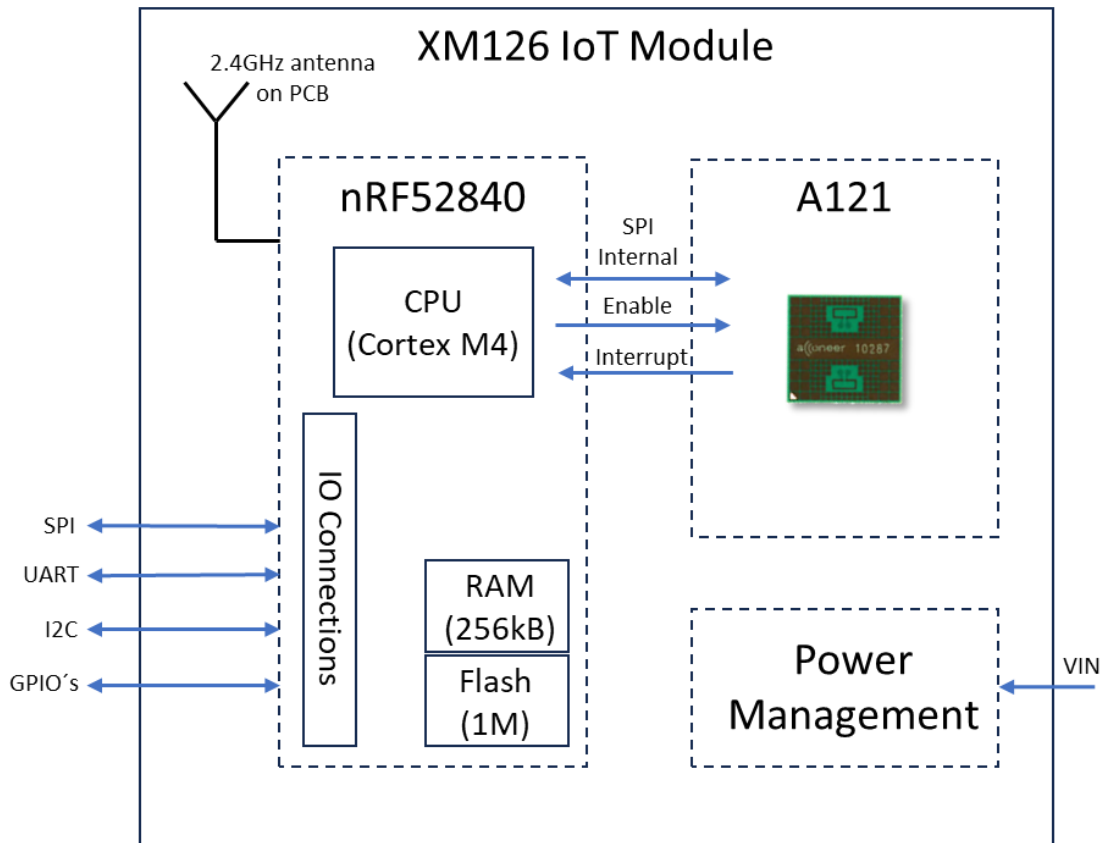

Figure 2.1. XM126 block diagram.

The XM126 block diagram shows the A121 60 GHz PCR radar connected to the nRF52840 microcontroller. The module provides a pin connector where the MCU external I/F are accessible including single voltage supply.



## 2.4 Module board connector and pin description

The board-to-board connector provides the external interface to the module. Figure 2.2 shows the connector footprint and Table 2.1 describes each signal. All GPIOs on XM126 have an operating voltage of 1.8V.

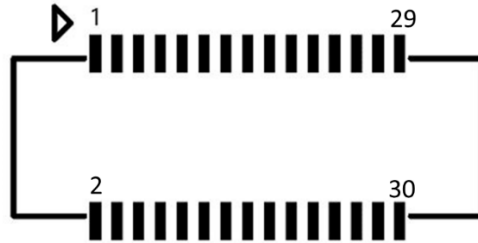

Figure 2.2. XM126 J2 connector footprint.

Pin Number	Signal	Description	nRF52840* pin
1	GPIO		P0.23
2	GND	Ground	-
3	GND	Ground	-
4	VIN	1.8-5.5 V external power supply. Pin 4 and Pin 6 are interconnected.	-
5	GPIO		P0.21
6	VIN	1.8-5.5 V external power supply. Pin 4 and Pin 6 are interconnected.	-
7	GND	Ground	-
8	GND	Ground	-
9	GPIO		P0.24
10	GPIO	Configurable as Analog Input.	P0.04
11	GND	Ground	-
12	GPIO	Configurable as JTAG Trace signal.	P0.11 TRACEDATA2
13	GPIO		P0.22
14	GPIO	Configurable as JTAG Trace signal.	P0.12 TRACEDATA1
15	GND	Ground	-
16	VDD	Regulated 1.8 V output voltage.	-
17	GPIO/UART_RX	Default configuration in Acconeer exploration server and SDK is UART. Could also be used as miscellaneous GPIO.	P0.06
18	GPIO, nRESET	nRF52840 reset pin.	P0.18 nRESET



19	GPIO/UART_TX	Default configuration in Acconeer exploration server and SDK is UART. Could also be used as miscellaneous GPIO.	P0.16
20	SWDIO	SWD interface for flash and debug.	SWDIO
21	GND	Ground	-
22	GPIO, SWO	SWD interface for flash and debug. Configurable as JTAG Trace signal.	P1.00 TRACEDATA0
23	GPIO	Configurable as JTAG Trace signal.	P0.07 TRACECLK
24	GND	Ground	-
25	GPIO	Configurable as JTAG Trace signal.	P1.09 TRACEDATA3
26	SWDCLK	SWD interface for flash and debug.	SWDCLK
27	GPIO/UART_RTS	Default configuration in Acconeer Exploration Server SW is UART. Could also be used as miscellaneous GPIO.	P0.20
28	GND	Ground	-
29	GPIO/UART_CTS	Default configuration in Acconeer Exploration Server SW is UART. Could also be used as miscellaneous GPIO.	P0.19
30	GPIO, DFU	Device Firmware Upgrade. Set low during reset to enter bootloader mode. Could also be used as miscellaneous GPIO.	P0.25

*Table 2.1. J2 connector pinout.*

## 2.5 Not mounted battery connector support

Not mounted battery connector (Reference Designator J3) supported on XM126 PCB. See chapter 5 schematics for further information. Example of compatible battery connectors:

- Vertical Amphenol 10114828-10102LF
- Horizontal Amphenol 10114828-1010LF
- Horizontal Molex 532617002





## 2.6 Software options

The XM126 module can be used as stand-alone module where the module operates as an independent system. The application is customized to a specific use case by the customer and runs on the embedded MCU. The customer application is accessing the RSS API.

Using the XM126 as stand-alone module Acconeer offers SDK that provides RSS, hardware abstraction layer, device drivers and build system. Based on SDK it is possible for the customer to develop their own application. Both RSS and applications runs on the embedded MCU.

## 2.7 MAC addresses

The XM126 module comes with a Static Random Bluetooth Address provided by the Nordic nRF52840 SoC. This address is assigned randomly during manufacturing. This static address can be used for evaluation.



## 3 Interfaces

### 3.1 Module supply input

The XM126 support external single power supply for battery power applications, see table 4.2 recommended operating conditions.

Note that supply voltage conditions (E.g. slew rate) need to be taken into consideration according to nRF52840 datasheet, ref [4].

### 3.2 System functions

Module RESET is supported by activating NRST pin (active low).

### 3.3 Serial interfaces

The XM126 nRF52840 GPIO pins can be configured to support up to two UART, up to four SPI master or three SPI slave and up to two I2C compatible 2-wire master/slave external serial interfaces. See table 2.1 for HW configuration. See also nRF52840 datasheet, ref [4] for further information.

### 3.4 Digital I/O interfaces

The XM126 module support General Purpose IOs (GPIOs) that operates at 1.8V, 16 GPIOs are available. The GPIO pins are configurable for different functions, only the debug and RESET pins are fixed to specific GPIOs. See table 2.1 for HW configuration. See also nRF52840 datasheet, ref [4] for further information.

### 3.5 Analog I/O interfaces

The XM126 module support one analog input (pin 10 on XM126 connector J2) and up to four individual PWM outputs which can be assigned to any of the GPIO pins. See table 2.1 for HW configuration.

### 3.6 Module reset

The XM126 has an external reset option (Pin 18 on XM126 connector J2) that can be configured as a GPIO or RESET input.

### 3.7 Debug interface

The XM126 has 7 debug pins, SWDIO, SWDCLK and Trace signals. TRACE signals reuse GPIO pins. The debug pins have an operating voltage of 1.8V. See table 2.1 for HW configuration.



## 4 Electrical specifications

### 4.1 Absolute maximum ratings

The below table shows the XM126 absolute maximum ratings over operating temperature range, unless otherwise noted:

Parameter	Description	Min.	Max.	Unit
V <sub>IN</sub>	power supply	-0.3	6.0	V
I/O	Voltage on I/O pins	-0.3	2.1	V
T <sub>OP</sub>	Operating temperature range	-40	85	°C
T <sub>STG</sub>	High temperature storage		125	°C

Table 4.1. Absolute maximum ratings.

Stresses beyond those listed in table 5.1 may cause permanent damage to the device. These are stress ratings only and functional operation of the device at these conditions or at any other conditions beyond those indicated under Recommended Operating Conditions is not implied. Exposure to absolute-maximum-rated conditions for extended periods of time may affect device reliability.

### 4.2 Recommended operating conditions

The below table shows the XM126 recommended operating conditions:

Parameter	Min.	Typ.	Max.	Unit
V <sub>IN</sub> , operating power supply voltage <sup>1)</sup>	1.8		5.5	V
I/O operating range	0		1.8	V
Operating temperature <sup>1)</sup>	-40		85	°C

Table 4.2. Recommended operating conditions.

<sup>1)</sup> Minimum battery voltage depends on battery internal resistance and temperature.



### 4.3 Power consumption summary

The below table summarizes the XM126 power consumption, maximum current ratings and average current ratings at power terminal at  $T_A = 25^\circ\text{C}$  and 2.0 V/3.0 V supply:

Parameter	Min.	Typ.	Max.	Unit
Average power consumption, 2.0 V supply, 0.1 Hz update rate		1.67 (1)		mW
Average power consumption, 3.0 V supply, 0.1 Hz update rate		1.68 (1)		mW
Average power consumption, 2.0 V supply, 1 Hz update rate		16.6 (1)		mW
Average power consumption, 3.0 V supply, 1 Hz update rate		16.7 (1)		mW
Average power consumption, 2.0 V supply, 2 Hz update rate		33.4 (1)		mW
Average power consumption, 3.0 V supply, 2 Hz update rate		33.5 (1)		mW
Average power consumption, 2.0 V supply, 1 Hz update rate		0.15 (2)		mW
Average power consumption, 3.0 V supply, 1 Hz update rate		0.15 (2)		mW
Average power consumption, 2.0 V supply, 2 Hz update rate		0.26 (2)		mW
Average power consumption, 3.0 V supply, 2 Hz update rate		0.26 (2)		mW
Idle current, 3.0V supply		4.35 (3)		$\mu\text{A}$

Table 4.3. Average power dissipation ratings at power terminal.

<sup>1</sup> Configuration according to the 'Medium Tank'-preset in the Tank Level Reference Application. Bluetooth advertisement according to given update rate.

<sup>2</sup> Configuration according to the 'Low Power Wakeup'-preset in the Presence Detector Example Application. Bluetooth advertisement according to given update rate.

<sup>3</sup> Sensor is disabled and nRF52840 is in sleep mode (System ON) with full RAM retention and wake-up on RTC enabled.

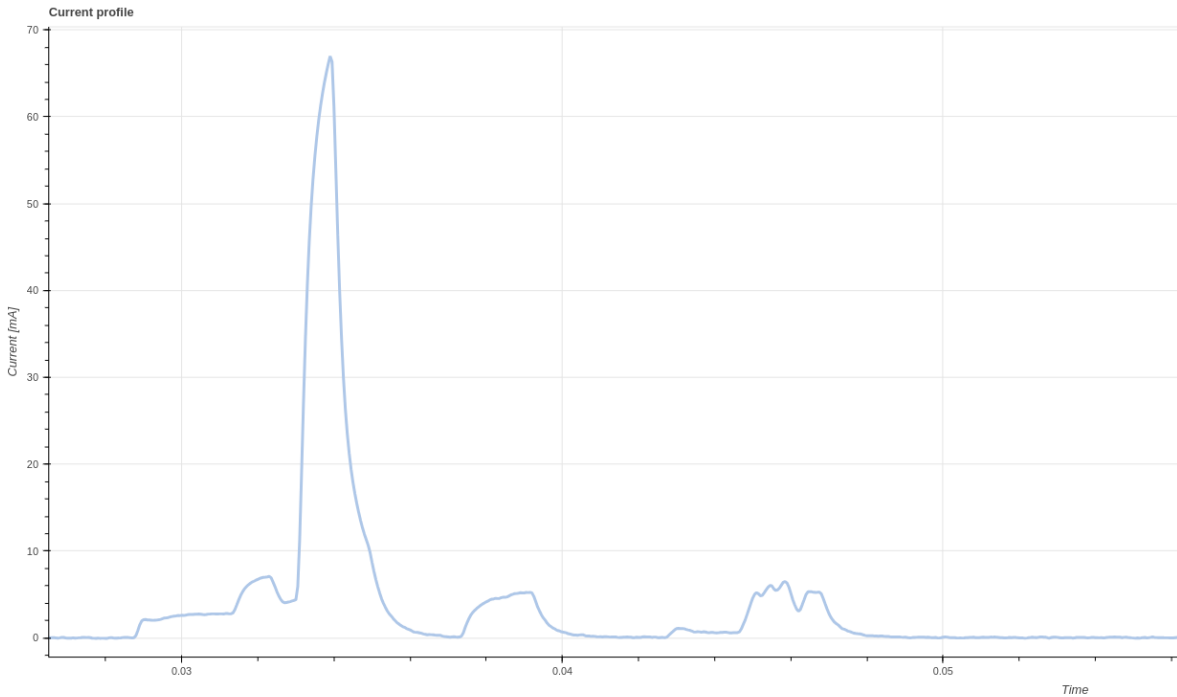

Figure 4.1. Current profile, Low Power Wakeup, 2.0V supply.

## 4.4 RF specification

The below table shows the XM126 A121 PCR RF specification:

Parameter	Min.	Typ.	Max.	Unit
Operating frequency range	57		64	GHz
EIRP (Equivalent Isotropically Radiated Power)		11		dBm
TX HPBW (Half Power Beam Width), elevation plane <sup>(1)</sup>	42	53	64	degrees
TX HPBW (Half Power Beam Width), horizontal plane <sup>(1)</sup>	52	65	78	degrees

Table 4.4. XM126 RF specification.

<sup>(1)</sup>Based on simulation

The XM126 support Bluetooth v5.4 including BLE, mesh, long range and advertising extensions.

The below table shows the XM126 Bluetooth radio performance:

Parameter	Min.	Typ.	Max.	Unit
Frequency (40 channels)	2.4		2.48	GHz
Supported data rates		512 kbps – 2 Mbps		Mbps
EIRP (4 dBm conducted power) <sup>1</sup>		7.3		dBm
Antenna gain		3.3		dB

Table 4.5. XM126 Bluetooth radio performance.

<sup>1</sup> Output power can be increased to 8 dBm but the power spectral density requirement in EN 300 328 of 10 dBm/MHz must be compliant for the intended Bluetooth data rate.



## 5 Reference design description

### 5.1 Schematics & BOM

The following pages include the module schematics and bill of materials:



# XM126 IoT Module Datasheet v1.3

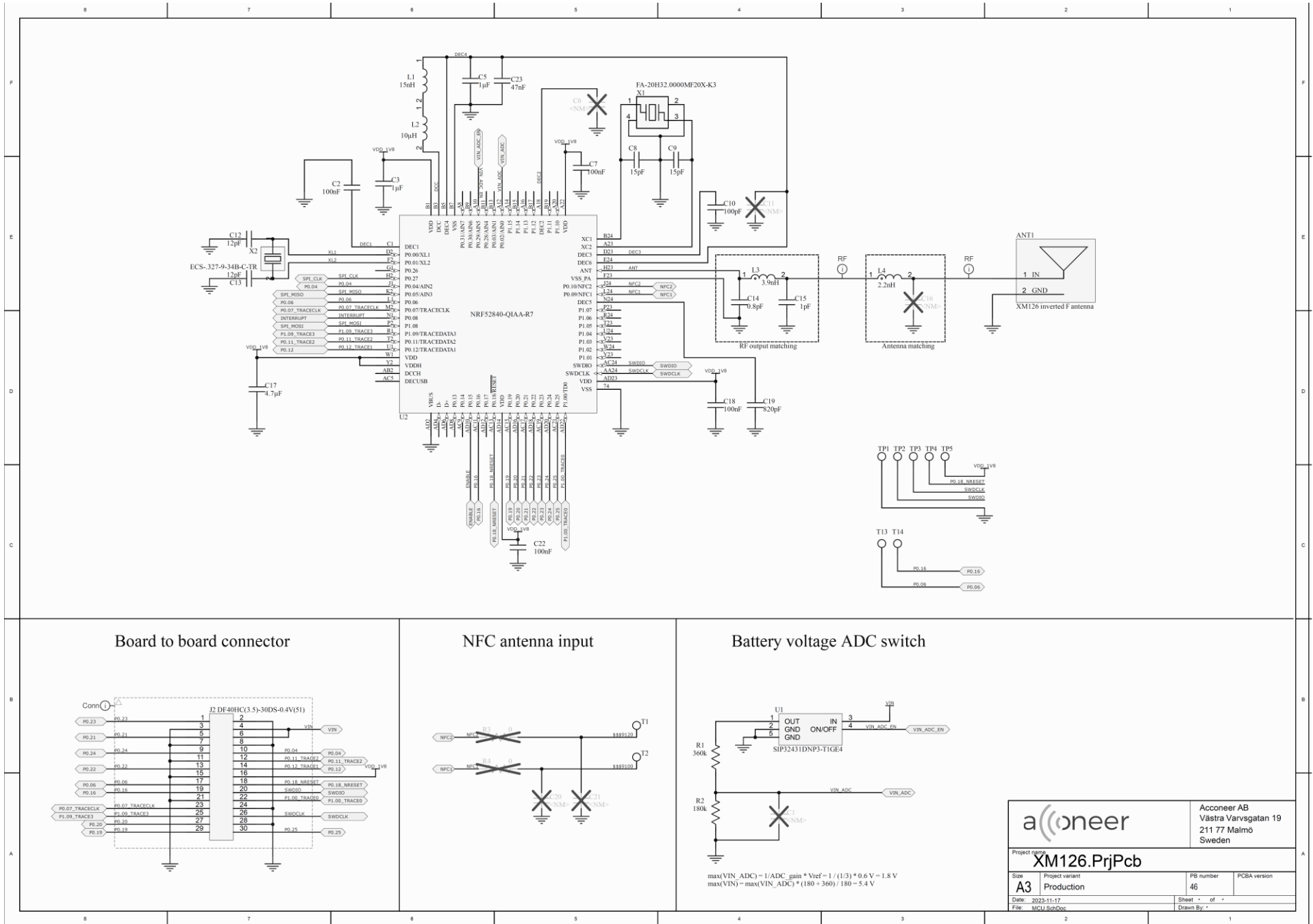

**Board to board connector**

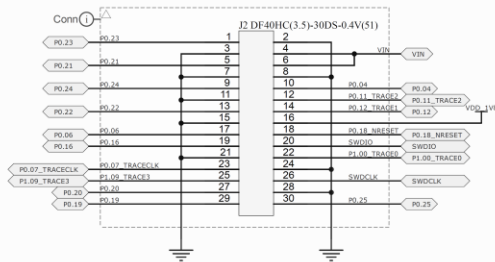

**NFC antenna input**

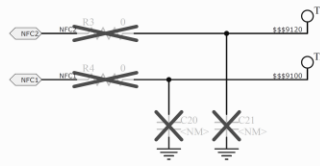

**Battery voltage ADC switch**

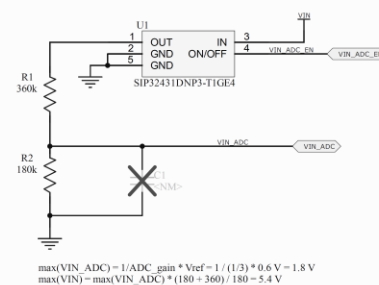

		Acconeer AB Västra Varvsgatan 19 211 77 Malmö Sweden	
		Project name <b>XM126.PrjPcb</b>	
Size <b>A3</b>	Project variant Production	PB number 46	PCBA version
Date: 2023-11-17 File: MCU_SchDoc		Sheet: * of * Drawn By: *	



# XM126 IoT Module Datasheet v1.3

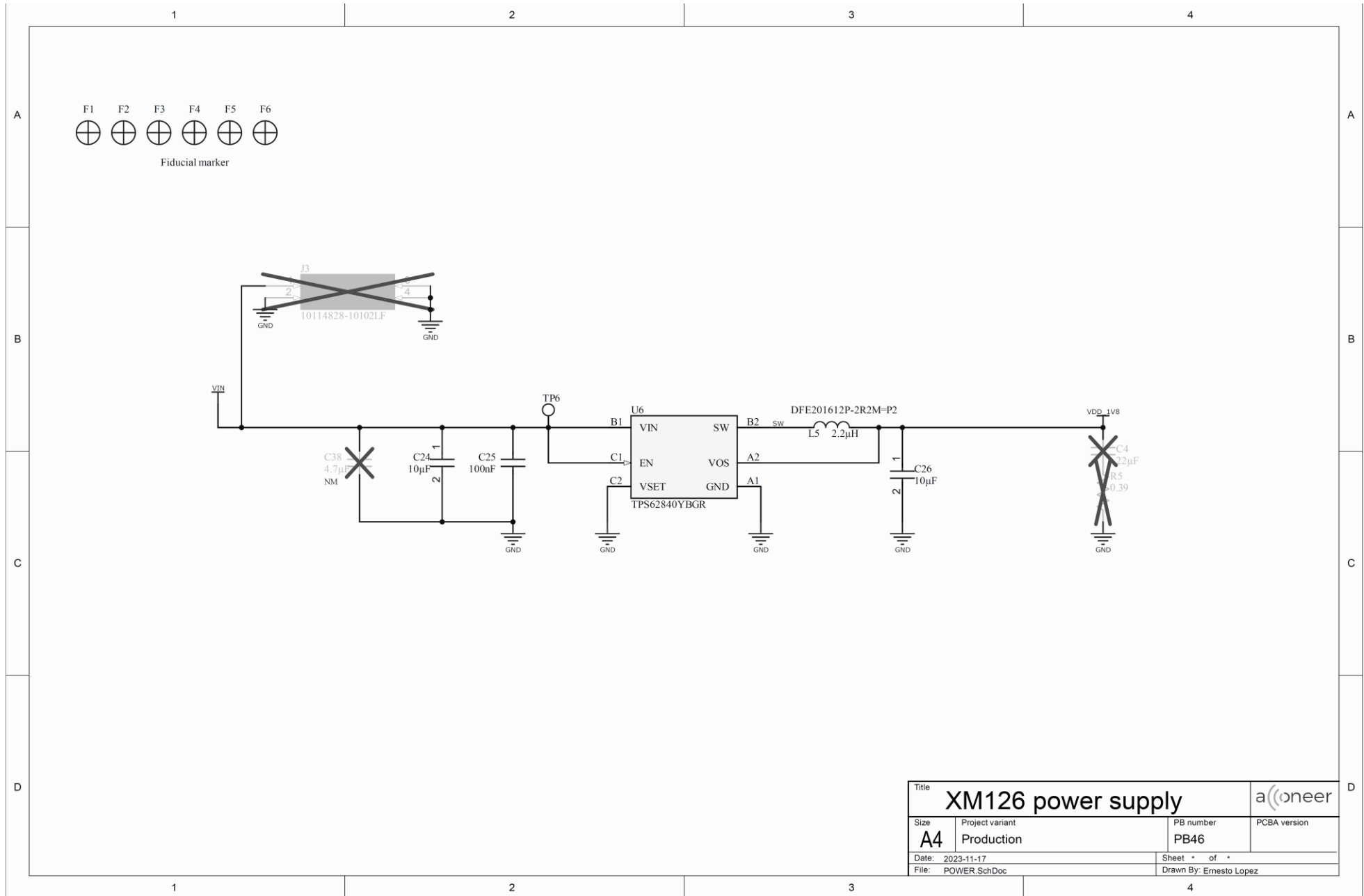





XM126 IoT Module  
Datasheet v1.3

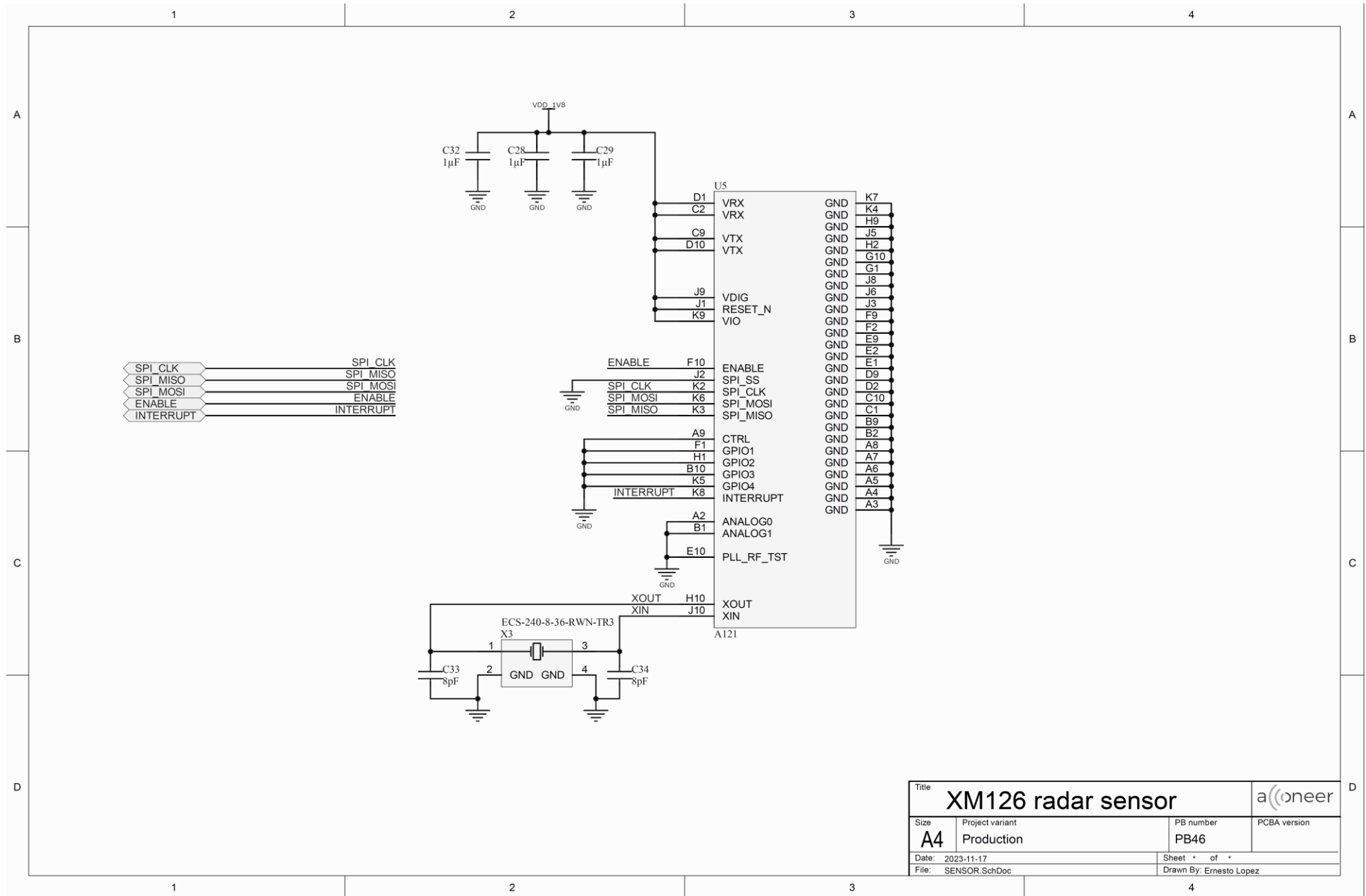



## Bill of Material

Table 5.1 shows the BOM for XM126.

Component Ref.	Specification	QTY	Value	Comment
C2, C7, C18, C22, C25	100nF/50V/10%/M1005/X7R	5	100nF	
C3, C5, C28, C29, C32	1uF/10V/10%/M1005/X5R	5	1uF	
C8, C9	15pF/50V/5%/M1005/COG	2	15pF	
C10	100pF/50V/10%/M1005/X7R	1	100pF	
C12, C13	12pF/50V/5%/M1005/COG	2	12pF	
C14	0.8pF/50V/5%/M1005/COG	1	0.8pF	
C15	1pF/50V/5%/M1005/NPO	1	1pF	
C17	4.7uF/10V/10%/M1005/X5R	1	4.7uF	
C19	820pF/50V/5%/M1005/NPO	1	820pF	
C23	47nF/50V/10%/M1005/X7R	1	47nF	
C24, C26	10uF/16V/10%/M2012/X7R	2	10uF	
C33, C34	8pF/50V/5%/M1005/COG	2	8pF	
J2	DF40HC(3.5)-30DS-0.4V(51)	1		Board-to-board connector
L1	15nH/5%/320mOhm/M1005	1	15nH	LQG15HS15NJ02D
L2	10uH/20%/600mOhm/M1608	1	10uH	MLZ1608N100LTO00
L3	3.9nH/+ 0.1nH/130mOhm/M1005	1	3.9nH	LQG15HN3N9B02D
L4	2.2nH/+0.1nH/90mOhm/M1005	1	2.2nH	LQG15HN2N2B02D
L5	2.2uH/20%/144mOhm/M2016	1	2.2uH	DFE201612P-2R2M=P2
R1	360kOhm/1%/M1005	1	360kOhm	0.0625W@70°C, 50V
R2	180kOhm/1%/M1005	1	180kOhm	0.0625W@70°C, 50V
U1	SIP32431DNP3-T1GE4	1	N/A	Power switch
U2	nRF52840-QIAA	1	N/A	MCU/BT module
U5	A121	1	N/A	Acconeer Pulsed Coherent Radar
U6	TPS62840YBGR	1	N/A	Power Regulator
X1	32MHz/10ppm/10pF/50Ohm	1	32 MHz	FA-20H32.0000MF20X-K3



X2	32.768kHz/10ppm/9pF/70kOhm	1	32.768kHz	ECS-.327-9-34B-C
X3	24MHz/15ppm/8pF/60Ohm	1	24 MHz	ECS-240-8-36-RWN

*Table 5.1. XM126 BOM list.*



## 5.2 Component Placement Drawing

The component placement drawing of XM126 is found below:

Top side:

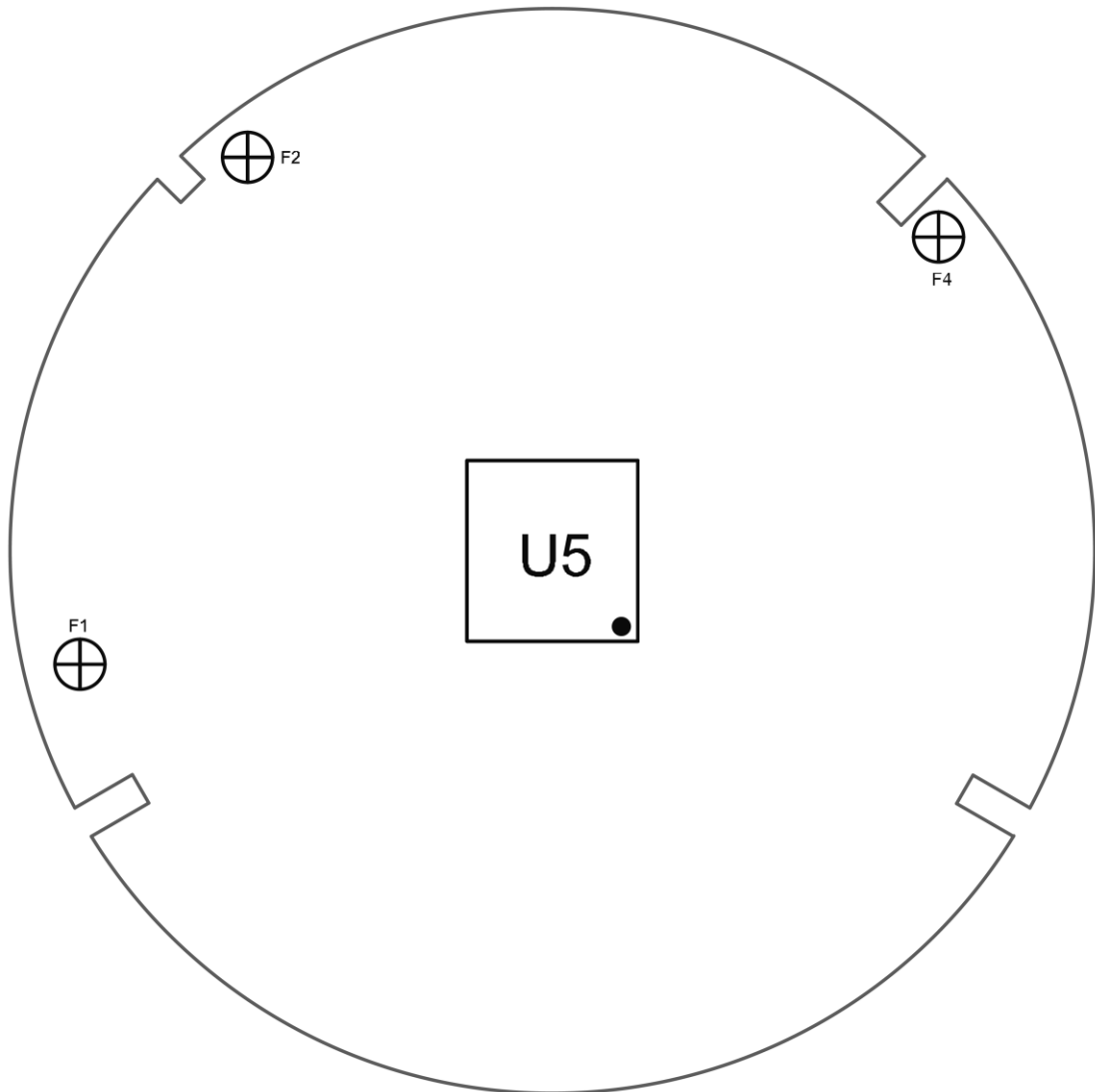



Bottom side:

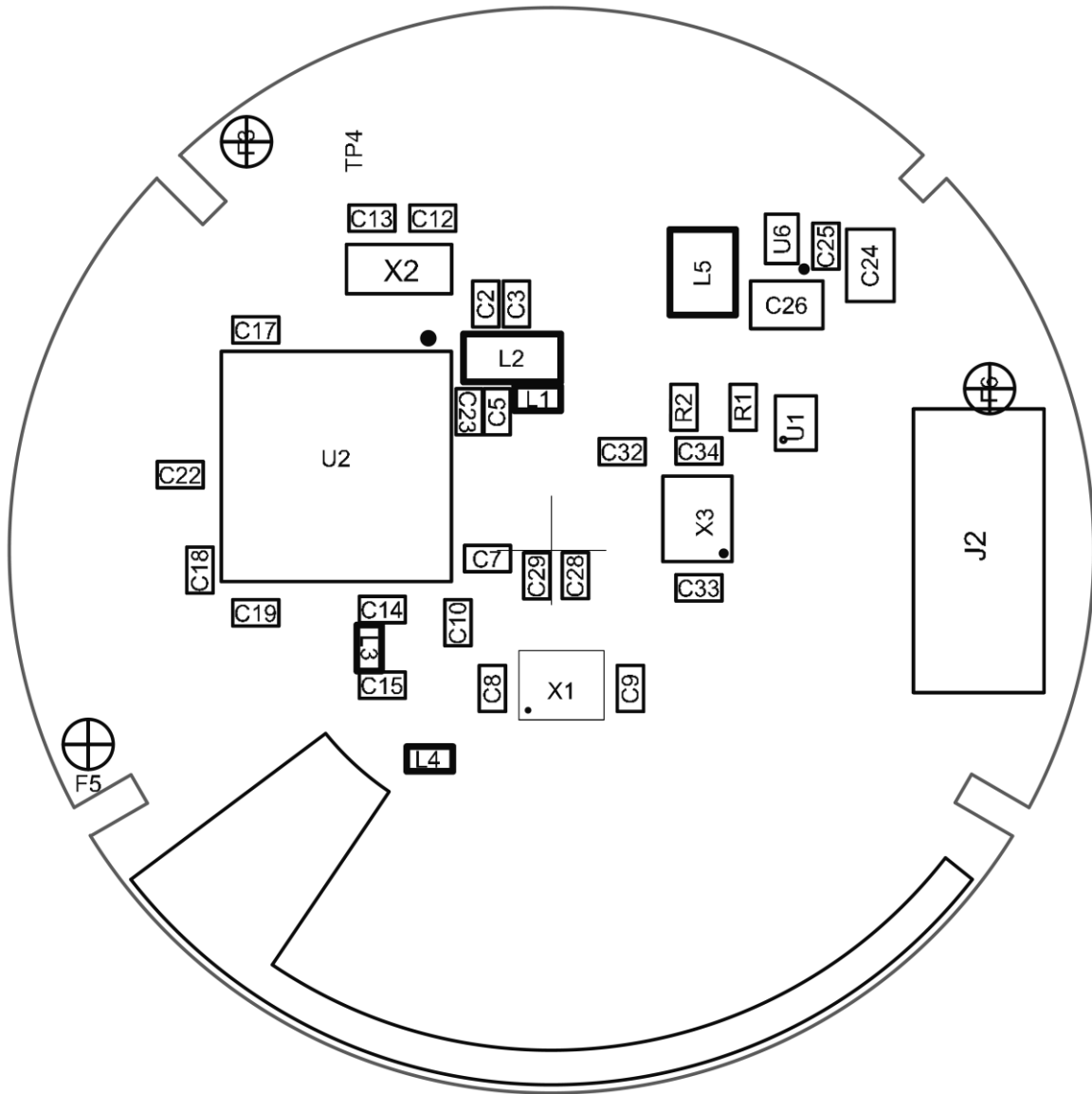



## 6 Mechanical specifications

XM126 Module outline – Top view





XM126 Module outline – Side view



Distance	Value	Tolerance
D1	33.0 mm	+/-0.2 mm
G1	1.0 mm	+/-0.2 mm
G2	2.0 mm	+/-0.2 mm
G3	1.0 mm	+/-0.2 mm
H1	0.82 mm	+/-0.07 mm
H2	0.8 mm	+/-0.08 mm
H3	3.4 mm	+/-0.15 mm



## 7 Regulatory Approval

To be noted is that some regulatory specifications also specify usage of the module, so users of the module must check regulatory requirements for their own use case and determine if the regulatory approvals described below are sufficient.

### 7.1 ETSI

Hereby, Acconeer declares that the XM126 module is compliant with directive 2014/53/EU. The XM126 module fulfills the CE marking.

EU Type Examination Certificate  
 cetecom advanced GmbH  
 Untertueckelmer Str. 6-10 | 66117 Saarbruecken | Germany | www.cetecomadvanced.com



**Certificate Holder:** Acconeer AB  
 Västra Varvgatan 19,  
 211 77 Malmö,  
 Sweden

**Product Manufacturer:** See Certificate Holder

**Product Designation:** XM126

**Product Description:** IoT module



Bundesnetzagentur

BNetzA-bS-02/51-52

authorized by the German Government to act as Notified Body in accordance with the RE Directive 2014/53/EU of 16 April 2014.

**Conformity Assessment:**

Essential requirements	Examined documentation	Result
Radio spectrum RED, Article 3.2	Technical documentation including test report(s)	conform
EMC RED, Article 3.1b	Technical documentation including test report(s)	conform

**EU Type Examination Certificate:**  
 In accordance with Annex III of the European Council Directive 2014/53/EU on radio equipment, we state that the identified equipment type complies with the essential requirements stated above. The scope of this evaluation relates to the submitted documents only.

**Marking:**  
 The product shall be marked with the CE marking as required in the Council Directive 2014/53/EU.

**Annexes:**  
 The certificate is only valid in conjunction with the following number of annexes: 1

**Validity:**  
 The validity of this certificate is limited to 5 years after the date of issue. Revisions of the applied standards and/or modifications of the approved type that may affect the conformity of the radio equipment with the essential requirements of Directive. 2014/53/EU may also have an impact on the validity of this certificate.

**CE 0682**

Certificate Registration No.: EU23-0044-01-TEC

cetecom advanced GmbH  
 cn=Uwe Nauzer, o=cetecom advanced GmbH,  
 ou=NAU-230601,  
 email=uwe.nauzer@cetecomadvanced.com, c=DE  
 202404.12.14:55:09+02:00

*Uwe Nauzer*  
 Authorized signature / title



GERMAN NOTIFIED BODY  
 EUROPEAN ID-NO. 0682





## 7.2 FCC Approval

The XM126 pending BLE limited modular approval granted by FCC.



## 8 Reference documents

- [1] A121 Pulsed Coherent Radar (PCR) Datasheet:  
<https://www.acconeer.com/products>
- [2] XM126 IoT Module Evaluation Kit, User guide  
<https://www.acconeer.com/products>
- [3] XB122 IoT Module Breakout board, Product brief  
<https://www.acconeer.com/products>
- [4] Nordic nRF52840:  
[Nordic Semiconductor](https://www.nordicsemi.com/Products/Development-modules/nRF52840)
- [5] User Guide – Sensor Integration Electromagnetic Scattering  
<https://www.acconeer.com/products>



## 9 Abbreviations

AiP	Antenna in Package
API	Application Programming Interface
BLE	Bluetooth Low Energy
BOM	Bill of Materials
EIRP	Equivalent Isotropically Radiated Power
GND	Ground
GPIO	General Purpose Input/Output
HPBW	Half Power Beamwidth
HW	HardWare
I2C	Inter-Integrated Circuit
MAC	Media Access Control
MCU	MicroController Unit
NVM	Non-Volatile Memory
PCR	Pulse Coherent Radar
RF	Radio Frequency
RSS	Radar System Software
SDK	Software Development Kit
SoC	System on Chip
SPI	Serial Peripheral Interface
SW	SoftWare
SWD	Serial Wire Debug
UART	Universal Asynchronous Receiver/Transmitter



## Disclaimer

The information herein is believed to be correct as of the date issued. Acconeer AB (“**Acconeer**”) will not be responsible for damages of any nature resulting from the use or reliance upon the information contained herein. Acconeer makes no warranties, expressed or implied, of merchantability or fitness for a particular purpose or course of performance or usage of trade. Therefore, it is the user’s responsibility to thoroughly test the product in their particular application to determine its performance, efficacy and safety. Users should obtain the latest relevant information before placing orders.

Unless Acconeer has explicitly designated an individual Acconeer product as meeting the requirement of a particular industry standard, Acconeer is not responsible for any failure to meet such industry standard requirements.

Unless explicitly stated herein this document Acconeer has not performed any regulatory conformity test. It is the user’s responsibility to assure that necessary regulatory conditions are met and approvals have been obtained when using the product. Regardless of whether the product has passed any conformity test, this document does not constitute any regulatory approval of the user’s product or application using Acconeer’s product.

Nothing contained herein is to be considered as permission or a recommendation to infringe any patent or any other intellectual property right. No license, express or implied, to any intellectual property right is granted by Acconeer herein.

Acconeer reserves the right to at any time correct, change, amend, enhance, modify, and improve this document and/or Acconeer products without notice.

This document supersedes and replaces all information supplied prior to the publication hereof.

© 2024 by Acconeer – All rights reserved



Acconeer AB  
Västra Varvsgatan 19  
211 77 MALMÖ  
Sweden

[www.acconeer.com](http://www.acconeer.com)  
[info@acconeer.com](mailto:info@acconeer.com)  
+46 10 218 92 00